



**Robertsfors
Försäljnings AB**



















Fästelement

Kapitel 08 Muttrar



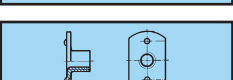







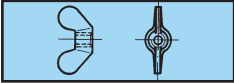

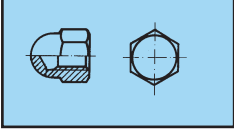
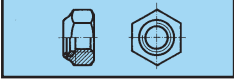
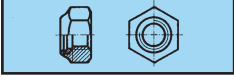



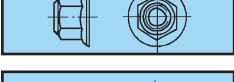

MUTTRAR

SIDA













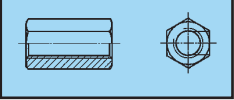

	M6M DIN 934 KL 8 OBEH	8:1
	M6M DIN 934 KL 8 FZB	8:2
	M6M DIN 934 KL 6 OBEH, FZB	8:3
	M6M DIN 934 KL 8 FZV	8:3
	M6M DIN 934 KL 8 GK, SVARTOXID, SVARTKROM, DACROLIT	8:4
	M6M DIN 934 KL 8 VÄNSTERGÄNGAD OBEH, FZB	8:4
	M6M DIN 934 KL 6 FINGÄNGAD OBEH, FZB	8:5
	M6M DIN 934 KL 8 FINGÄNGAD OBEH, FZB	8:5
	ISO 4032 KL 8 OBEH, FZB, FZV ZJSV	8:6
	ISO 4032 KL 10 OBEH, DACROLIT	8:6
	M6M DIN 934 KL 10, KL 12	8:7
	M6M DIN 934 KL 10 FINGÄNGAD	8:7
	ML6M OBEH, FZB	8:8
	DIN 439B OBEH, FZB	8:8
	DIN 936 OBEH, FZB	8:9
	LÅG MUTTER MED STOR NYCKELVIDD FZB	8:9
	DIN 439B FINGÄNGAD OBEH, FZB	8:10
	DIN 936 FINGÄNGAD OBEH, FZB	8:10
	DIN 936 VÄNSTER OBEH, FZB	8:11
	ISO 4035 OBEH, FZB	8:11
	TK6M DIN 929 SVETSMUTTER OBEH	8:12
	TK4M DIN 928 SVETSMUTTER OBEH, METRISK/UNC/UNF	8:12
	FN 4-KANT SVETSMUTTER OBEH	8:12
	FK4M SVETSMUTTER OBEH	8:13
	SVETSMUTTER MED REKTANGULÄR PLATTA OBEH	8:13
	VINGMUTTER DIN 315 OBEH, FZB	8:14
	VINGMUTTER AMERIKANSK FORM FZB	8:14
	VINGMUTTER JAPANSK FORM FZB, METRISK/UNC/UNF	8:15

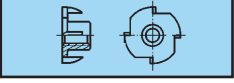
MUTTRAR

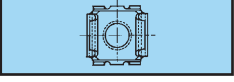
		SIDA
	VINGMUTTER "DIN 315" UVM UNC-GÄNGA FZB	8:15
	U6M UNC-, UNF-GÄNGA OBEH, FZB, FZV U6M UNC VÄNSTER OBEH, FZB	8:16 8:16
	MHM DIN 1587 OBEH FZB SVARVAD KUPOL FZB KUPOLMUTTER JAPANSK FORM FZB UHM FZB, UNC-GÄNGA	8:17 8:17 8:17
	LÅSMUTTER DIN 985 KL 6 FZB LÅSMUTTER DIN 985 KL 8 FZB	8:18 8:18
	LÅSMUTTER HÖG DIN 982 KL 8 FZB LÅSMUTTER DIN 6924 KL 8 FZB	8:19 8:19
	LÅSMUTTER DIN 985 KL 6 FINGÄNGAD FZB LÅSMUTTER DIN 985 KL 10 FINGÄNGAD FZB	8:20 8:20
	LÅSMUTTER DIN 985 KL 10 FZB LÅSMUTTER DIN 6924 KL 10 FZB	8:21 8:21
	LÅSMUTTER DIN 980 KL 8 HELMETALLISK FZB LÅSMUTTER DIN 980 KL 8 HELMETALLISK FZB FINGÄNGAD	8:22 8:22
	LÅSMUTTER DIN 6925 KL 8 HELMETALLISK FZB	8:23
	FLÄNSLÅSMUTTER DIN 6926 KL 8 MED PLASTINSATS FZB	8:23
	FLÄNSLÅSMUTTER DIN 6927 KL 8 HELMETALLISK FZB	8:24
	LÅSMUTTER DIN 980 KL 8 HELMETALLISK MED FJÄDRANDE LÅSBRIKKA FZV	8:24
	KUPOLLÅSMUTTER DIN 986 FZB	8:25
	LÅSMUTTER IFI 100 MED PLASTINSATS UNC- OCH UNF-GÄNGA FZB	8:25
	FLÄNSMUTTER DIN 6923 KL 8 FZB	8:26
	FLÄNSMUTTER MED LÅSTÄNDER DIN 6923 KL 8 FZB	8:26
	M6MF KL 8 HÖG OBEH FZB	8:26
	MKM KRONMUTTER DIN 935-1 KL 6 OBEH, FZB MKM KRONMUTTER DIN 935-1 KL 6 FINGÄNGAD FZB	8:27 8:27

MUTTRAR

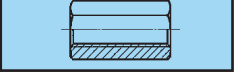
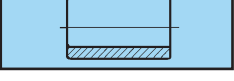
SIDA

	DIN 557 OBEH, FZB	8:28
	DIN 562 OBEH, FZB	8:28
	6-KANTSMUTTER LÅG W-GÅNGA FZB	8:28
	M6HM OBEH, FZB	8:29
	DIN 6334 FZB	8:29
	U6HM UNC-GÅNGA OBEH	8:29
	DIN 6330 FORM A KL 6	8:30
	DIN 6330 FORM B KL 6	8:30
	DIN 6330 FORM B KL 10	8:30
	DIN 6331 KL 10	8:30
	ISLAGSMUTTER OBEH, FZB	8:31
	DIN 466 OCH DIN 467 FZB	8:31
	KORGMUTTER SMG, MC OCH CV FZB, GK	8:32
	SNABBLÅSMUTTER FÖR PLÅTSKRUV SNU OBEH, FZB	8:33
	SNABBLÅSMUTTER FÖR PLÅTSKRUV SNJ, SNP OCH NU OBEH, GK	8:34
	SNABBLÅSMUTTER FÖR METRISK SKRUV NUT FZB	8:35
	DISTANSMUTTER 6-KANT FZB	8:36, 8:37
	DISTANSMUTTER RUND FZB	8:38
	PRESSMUTTER KALEI® SÄTTHÄRDAD FZB	8:39
	NITMUTTER ANCHOR ARB FZB	8:40

MUTTRAR

SIDA

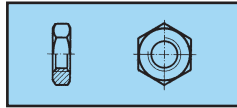

UL6M UNC-GÄNGA OBEH, FZB, FZV

8:41

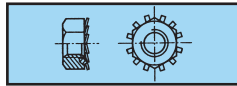

KOMBIMUTTER M LÅSBRICKA

8:41



MUTTERSÄKRING FJÄDERSTÅL DIN 7967 OBEH, FZB

8:42

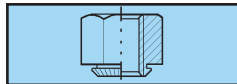

PRESSMUTTER BN 201 FZB

8:42

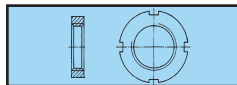

DIN 981

8:43

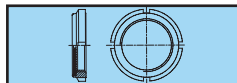

LÅSMUTTER CRN/CRP

8:44



MUTTER DIN 6915 KL 10, SE SID 2:26-2:27

M6M

DIN 934
STÅL KLASS 8 OBEH

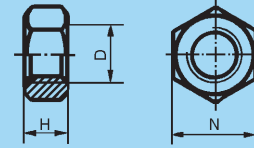

D	N	H	PRIS KRONOR PER 100 ST.					
			SMÅPACK		INDUSTRIPACK		NORMALPACK	
			FÖRP.	PRIS	FÖRP.	PRIS	FÖRP.	PRIS
M3	5,5	2,4	200	12	85000	8	1000	9
M3,5	6	2,8					500	11
M4	7	3,2	200	13	42000	10	1000	11
M5	8	4	200	15	26000	12	500	13
M6	10	5	200	20	13000	17	500	18
M7	11	5,5					500	48
M8	13	6,5	200	34	5700	29	500	31
M10	17	8	100	73	2700	67	200	69
M12	19	10	100	109	1700	95	200	96
M14	22	11					200	175
M16	24	13	50	219	850	190	100	198
M18	27	15					100	380
M20	30	16	25	449	430	410	50	424
M22	32	18					50	790
M24	36	19	25	876	240	810	50	840
M27	41	22					25	1760
M30	46	24					25	2160
M33	50	26					10	2610
M36	55	29					10	3700
M39	60	31					10	5650
M42	65	34					LÖSA	7650
M45	70	36					LÖSA	8910
M48	75	38					LÖSA	12700
M52	80	42					LÖSA	17100
M56	85	45					LÖSA	24300
M60	90	48					LÖSA	28800
M64	95	51					LÖSA	35100
M68	100	54					LÖSA	49000
M72x6	105	58					LÖSA	68000
M76x6	110	61					LÖSA	104000
M80x6	115	64					LÖSA	144000
M85x6	120	68					LÖSA	149000
M90x6	130	72					LÖSA	288000
M95x6	135	76					LÖSA	296000
M100x6	145	80					LÖSA	299000

OM EJ ANNAT ANGES LEVERERAS NORMALPACK.

BEST.EX: M6M KLASS 8 M3 OBEH

DATA.EX: 9340030

M6M

DIN 934
STÅL KLASS 8 FÖRZINKAD

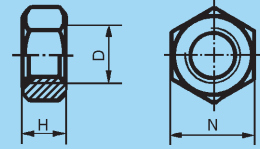

D	N	H	PRIS KRONOR PER 100 ST.					
			SMÅPACK		INDUSTRIPACK		NORMALPACK	
			FÖRP.	PRIS	FÖRP.	PRIS	FÖRP.	PRIS
M3	5,5	2,4	200	12	70000	9	1000	10
M3,5	6	2,8					1000	12
M4	7	3,2	200	14	32000	11	1000	12
M5	8	4	200	16	26000	13	500	14
M6	10	5	200	22	13000	18	500	19
M7	11	5,5					500	49
M8	13	6,5	200	36	5000	32	500	33
M10	17	8	100	79	2700	68	200	72
M12	19	10	100	128	1700	108	200	119
M14	22	11	100	197	1300	177	200	185
M16	24	13	50	253	800	215	100	230
M18	27	15	50	420			100	390
M20	30	16	25	498	400	460	50	470
M22	32	18					50	830
M24	36	19	25	930	240	865	50	890
M27	41	22					25	1953
M30	46	24					25	2400
M33	50	26					10	2900
M36	55	29					10	3900
M39	60	31					10	5900
M42	65	34					LÖSA	8500
M45	70	36					LÖSA	9900
M48	75	38					LÖSA	14100
M52	80	42					LÖSA	19000
M56	85	45					LÖSA	27000
M60	90	48					LÖSA	32000
M64	95	51					LÖSA	39000
M68	100	54					LÖSA	66000
M72x6	105	58					LÖSA	82000
M76x6	110	61					LÖSA	124000
M80x6	115	64					LÖSA	173000
M85x6	120	68					LÖSA	179000
M90x6	130	72					LÖSA	346000
M95x6	135	76					LÖSA	355000
M100x6	145	80					LÖSA	359000

OM EJ ANNAT ANGES LEVERERAS NORMALPACK.

BEST.EX: M6M KLASS 8 M3 FZB

DATA.EX: 93400301

M6M

DIN 934
STÅL KLASS 6 OBEH, FZB

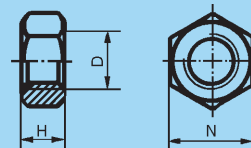

D	N	H	FÖRPACKNINGAR	PRIS KRONOR PER 100 ST.	
				OBEH	FZB
M1	2,5	0,8	100		489
M1,2	3	1,0	100		366
M1,4	3	1,2	100		312
M1,6	3,2	1,3	100		202
M1,7	3,5	1,4	100		178
M2	4	1,6	1000	69	24
M2,3	4,5	1,8	100		95
M2,5	5	2	1000	29	24
M2,6	5	2	100		39

BEST.EX: M6M KLASS 6 M1 FZB
DATA.EX: 93400101

M6M

DIN 934
STÅL KLASS 8 VARMFÖRZINKAD

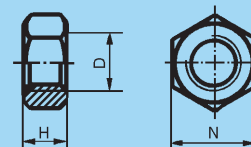

D	N	H	PRIS KRONOR PER 100 ST.					
			SMÅPACK		INDUSTRIPACK		NORMALPACK	
			FÖRP.	PRIS	FÖRP.	PRIS	FÖRP.	PRIS
M6	10	5					500	43
M8	13	6,5	200	64	5000	57	500	59
M10	17	8	100	120	2500	110	200	112
M12	19	10	100	159	1700	140	200	145
M14	22	11					200	590
M16	24	13	50	320	800	285	100	298
M18	27	15					100	530
M20	30	16	25	620	430	570	50	590
M22	32	18					50	1200
M24	36	19	25	1380	300	1250	50	1290
M27	41	22					25	2400
M30	46	24					25	3386
M33	50	26					10	3867
M36	55	29					10	4900
M39	60	31					LÖSA	7700
M42	65	34					LÖSA	13500
M45	70	36					LÖSA	15000
M48	75	38					LÖSA	17200
M56	85	45					LÖSA	38000

BEST.EX: M6M KLASS 8 M6 FZV
DATA.EX: 9340062

M6M

DIN 934
STÅL KLASS 8
GULKROM, SVARTOXID, SVARTKROM, DACROLIT

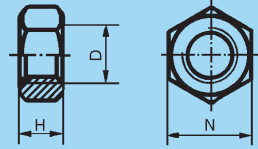

D	N	H	FÖRPACKNINGAR	PRIS KRONOR PER 100 ST.			
				GULKROMATERAD	SVARTOXID	SVARTKROM	DACROLIT
M3	5,5	2,4	1000	12		29	
M3,5	6	2,8	1000	15			
M4	7	3,2	1000	14	16	19	
M5	8	4	500	16	19	29	
M6	10	5	500	23	27	35	46
M8	13	6,5	500	38	43	49	59
M10	17	8	200	92	150	128	156
M12	19	10	200	142	240	198	240
M14	22	11	200	233			1900
M16	24	13	100	260			590
M18	27	15	100	490			1900
M20	30	16	50	510			1260
M24	36	19	50	1083			1800
M27	41	22	25	2540			3900
M30	46	24	25	2900			4800
M33	50	26	10	4100			6900
M36							9800

BEST.EX: M6M KLASS 8 M3 GK
DATA.EX: 93400303

M6M

VÄNSTERGÄNGAD
DIN 934
STÅL KLASS 8 OBEH, FZB

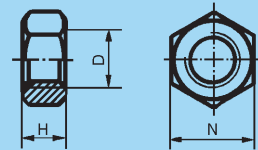

D	N	H	FÖRPACKNINGAR	PRIS KRONOR PER 100 ST.	
				OBEH	FZB
M3	5,5	2,4	100		251
M4	7	3,2	100	131	167
M5	8	4	100	165	179
M6	10	5	100	224	237
M8	13	6,5	100	350	372
M10	17	8	100	549	585
M12	19	10	100	729	765
M14	22	11	50	1188	1238
M16	24	13	50	1476	1553
M18	27	15	50	2052	2228
M20	30	16	50	2556	2700
M22	32	18	25	5900	6800
M24	36	19	25	4410	4950
M27	41	22	10	7920	8775
M30	46	24	10	10080	10800
M33	50	26	LÖSA	14220	
M36	55	29	LÖSA	29000	38000

BEST.EX: M6M KLASS 8 M4 VÄNSTERGÄNGAD OBEH
DATA.EX: 934L04

M6M

FINGÄNGAD
DIN 934
STÅL KLASS 6 OBEH, FZB

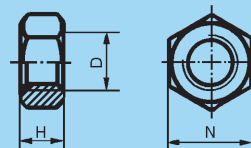

D	N	H	FÖRPACKNINGAR	PRIS KRONOR PER 100 ST.	
				OBEH	FZB
M3 x 0,35	5,5	2,4	1000		230
M4 x 0,5	7	3,2	1000		240
M5 x 0,5	8	4	1000		350
M6 x 0,5	10	5	500		360
M6 x 0,75	10	5	500	350	360

BEST.EX: M6M FINGÄNGAD KLASS 6 M3 x 0,35 FZB
DATA.EX: 934030351

M6M

FINGÄNGAD
DIN 934
STÅL KLASS 8 OBEH, FZB

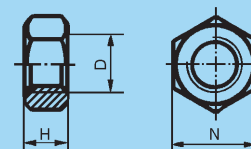

D	N	H	FÖRPACKNINGAR	PRIS KRONOR PER 100 ST.	
				OBEH	FZB
M8 x 1	13	6,5	100	491	540
M10 x 1	17	8	100	777	833
M10 x 1,25	17	8	100	777	833
M12 x 1	19	10	100	1025	1080
M12 x 1,25	19	10	100	1025	1080
M12 x 1,5	19	10	100	1025	1080
M14 x 1,5	22	11	100	1485	1598
M16 x 1,5	24	13	100	1890	2138
M18 x 1,5	27	15	50	2600	2700
M18 x 2	27	15	50	2858	3150
M20 x 1,5	30	16	50	3578	3938
M20 x 2	30	16	50	3578	3938
M22 x 1,5	32	18	25	4793	5288
M22 x 2	32	18	25	4793	5288
M24 x 1,5	36	19	25	6188	6750
M24 x 2	36	19	25	6188	6750
M27 x 2	41	22	10	12500	13200
M30 x 1,5	46	24	10	14175	14850
M30 x 2	46	24	10	14175	14850
M33 x 1,5	50	26	LÖSA	20025	21375
M33 x 2	50	26	LÖSA	20025	21375
M36 x 1,5	55	29	LÖSA	24300	27000
M36 x 2	55	29	LÖSA	39000	27000
M36 x 3	55	29	LÖSA	24300	27000

BEST.EX: M6M STÅL KLASS 8 M8 x 1 OBEH
DATA.EX: 93408100

M6M

NYCKELVIDD OCH HÖJD ENL ISO
ISO 4032
STÅL KLASS 8 OBEH, FZB, FZV, ZJSV

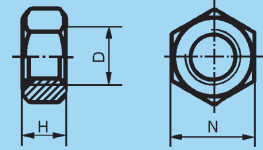

D	N	H	FÖRPACKNINGAR	PRIS KRONOR PER 100 ST.			
				OBEH	FZB	FZV	ZJSV
M3	5,5	2,4	1000	46	12		190
M4	7	3,2	1000	30	14		180
M5	8	4,7	500	39	18		175
M6	10	5,2	500	41	24	69	170
M8	13	6,8	500	49	39	72	168
M10	16	8,4	200	72	75	128	198
M12	18	10,8	200	120	134	165	269
M14	21	12,8	200	250	255	670	510
M16	24	14,8	100	259	265	372	690
M18	27	15,8	100	670	690	845	
M20	30	18	50	690	710	785	890
M22	34	19,4	50	1450	1495	1650	
M24	36	21,5	50	1490	1550	1765	
M27	41	23,8	25	2800	2900	3250	
M30	46	25,6	25	3100	3195	3600	
M33	50	28,7	10	4500	5600	9800	
M36	55	31	10	5900	7700	10400	

BEST.EX: ISO 4032 KLASS 8 M3 OBEH
DATA.EX: 40320030

M6M

NYCKELVIDD OCH HÖJD ENL ISO
ISO 4032
STÅL KLASS 10 OBEH, DACROMET

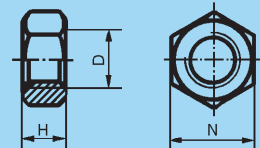

D	N	H	FÖRPACKNINGAR	PRIS KRONOR PER 100 ST.	
				OBEH	DACROMET
M6	10	5,2	500	129	260
M8	13	6,8	500	162	210
M10	16	8,4	200	356	430
M12	18	10,8	200	440	560
M14	21	12,8	200	970	
M16	24	14,8	100	730	910
M20	30	18	50	1100	1530
M24	36	21,5	50	2900	3500
M27	41	23,8	25	4200	
M30	46	25,6	25	5700	

BEST.EX: ISO 4032 KLASS 10 M6
DATA.EX: 40321006

M6M

DIN 934
STÅL KLASS 10/12

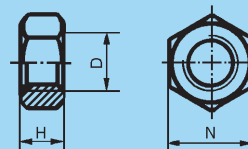

D	N	H	FÖRPACKNINGAR	PRIS KRONOR PER 100 ST.			
				KLASS 10			KLASS 12
				OBEH	FZB	DACROLIT	
M4	7	3,2	200	95			
M5	8	4	200	104			
M6	10	5	200	110	143		
M8	13	6,5	200	120	156		738
M10	17	8	100	289	376	480	1233
M12	19	10	100	390	507		1692
M14	22	11	100	590	790		2600
M16	24	13	50	640	832	970	2700
M18	27	15	50	920			
M20	30	16	50	950	1235		3600
M22	32	18	25	2600			
M24	36	19	25	2700	3510		5500
M27	41	22	25	3269			9400
M30	46	24	25	4600			19475
M33	50	26	10	6500			
M36	55	29	10	11853			26086
M39	60	31	LÖSA	29000			
M42	65	34	LÖSA	32000			
M45	70	36	LÖSA	43650			
M48	75	38	LÖSA	49000			
M56	85	45	LÖSA	59000			

BEST.EX: M6M KL 10 M4 OBEH
DATA.EX: 9341004

M6M

DIN 934
STÅL KLASS 10 FINGÄNGAD

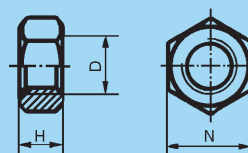

D	N	H	FÖRPACKNINGAR	PRIS KRONOR PER 100 ST.	
				OBEH	DACROLIT
M12 x 1,25	19	10	100	690	1800
M12 x 1,5	19	10	100	690	
M14 x 1,5	22	11	100	950	
M16 x 1,5	24	13	100	1100	
M18 x 1,5	27	15	50	1400	
M20 x 1,5	30	16	50	1590	
M22 x 1,5	32	18	25	3400	
M24 x 2	36	19	25	3900	
M27 x 2	41	22	25	7600	
M30 x 2	46	24	10	9900	

BEST.EX: M6M STÅL KLASS 10 M12 x 1,25
DATA.EX: 9341012125

ML6M

LÅG MUTTER
SS 2176 OBEH, FZB

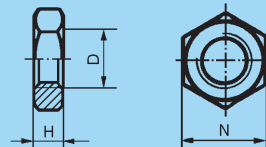

D	N	H	FÖRPACKNINGAR	PRIS KRONOR PER 100 ST.	
				OBEH	FZB
M4	7	2,5	1000		20
M5	8	3	1000		26
M6	10	4	1000		34
M8	13	5	500	81	59
M10	17	6	500	120	129
M12	19	8	100		199
M14	22	9	50		990
M16	24	10	50		290
M20	30	12	50		990

BEST.EX: ML6M STÅL M4 x 7 x 2,5 OBEH
DATA.EX: ML6M041

LÅG MUTTER

DIN 439 B
STÅL KL.04 OBEH, FZB

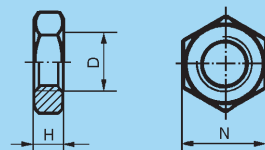

D	N	H	FÖRPACKNINGAR	PRIS KRONOR PER 100 ST.	
				OBEH	FZB
M2	4	1,2	500	53	54
M2,5	5	1,6	500	50	51
M3	5,5	1,8	500	27	35
M4	7	2,2	500	29	35
M5	8	2,7	500	41	36
M6	10	3,2	500	56	41
M8	13	4	500	108	51
M10	17	5	500	171	90
M12	19	6	200	279	153
M14	22	7	200		729
M16	24	8	100	518	293
M18	27	9	100		1053
M20	30	10	50	790	638
M22	32	11	50	1560	2484
M24	36	12	50	2100	2808
M27	41	13,5	25		4671
M30	46	15	25	5325	5697
M33	50	16,5	LÖSA		9990
M36	55	18	LÖSA		11259
M39	60	19,5	LÖSA	11597	
M42	65	21	LÖSA	15296	

BEST.EX: DIN 439 B STÅL M2 OBEH
DATA.EX: 43902

LÅG MUTTER

DIN 936
STÅL KL.04/17 H OBEH, FZB

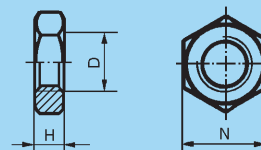

D	N	H	FÖRPACKNINGAR	PRIS KRONOR PER 100 ST.	
				OBEH	FZB
M12	19	7	500	435	518
M14	22	8	200	900	1025
M20	30	9	50	2205	2453
M22	32	10	50	3195	3488
M24	36	10	50	3780	4163
M27	41	12	25		6525
M30	46	12	25	7088	8505
M33	50	14	10		14580
M36	55	14	10	15000	15660
M39	60	16	LÖSA		21330
M42	65	16	LÖSA		27270
M45	70	18	LÖSA		32400
M48	75	18	LÖSA		41850
M52	80	20	LÖSA		48600

BEST.EX: DIN 936 STÅL M12 OBEH
DATA.EX: 93612

LÅG MUTTER

STOR NYCKELVIDD
STÅL FZB

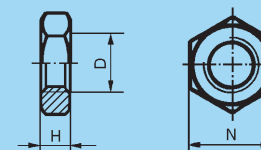

D	N	H	FÖRPACKNINGAR	PRIS KRONOR PER 100 ST.
M3	6	2	1000	50
M4	8	2,5	1000	59
M5	9	3	1000	125

BEST.EX: 6-KANTMUTTER STÅL M3 x 6 x 2 FZB
DATA.EX: 6KTM3061

BUFAB

LÅG MUTTER

FINGÄNGAD
DIN 439 B
STÅL KL.04 OBEH, FZB

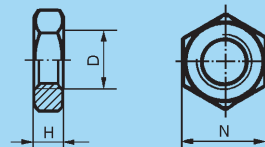

D	N	H	FÖRPACKNINGAR	PRIS KRONOR PER 100 ST.	
				OBEH	FZB
M8 x 1	13	4	100		336
M10 x 1	17	5	100	560	606
M10 x 1,25	17	5	100		626
M12 x 1	19	6	100	810	858
M12 x 1,25	19	6	100		858
M12 x 1,5	19	6	100		1080
M14 x 1,5	22	7	100		1328
M16 x 1,5	24	8	100		1407
M18 x 1,5	27	9	50	2300	2385
M20 x 1,5	30	10	50	3100	3173
M22 x 1,5	32	11	25		4793
M24 x 2	36	12	25		6660
M27 x 2	41	13,5	25		7400
M30 x 2	46	15	25		8600

BEST.EX: DIN 439 B STÅL M8 x 1 FZB
DATA.EX: 439081001

LÅG MUTTER

FINGÄNGAD
DIN 936
STÅL KL.04/17 H OBEH, FZB

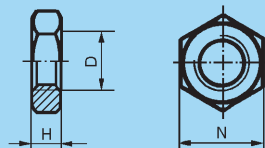

D	N	H	FÖRPACKNINGAR	PRIS KRONOR PER 100 ST.	
				OBEH	FZB
M10 x 1	17	6	500		650
M10 x 1,25	17	6	500		650
M12 x 1,25	19	7	500	878	1054
M12 x 1,5	19	7	500	878	1054
M14 x 1,5	22	8	200	1170	1404
M20 x 1,5	30	9	50	2498	2998
M20 x 2	30	9	50	2498	2998
M22 x 1,5	32	10	50	2970	3564
M22 x 2	32	10	50	2970	3564
M24 x 1,5	36	10	50	4050	4860
M24 x 2	36	10	50	4050	4860
M27 x 1,5	41	12	25	6863	8236
M27 x 2	41	12	25	6863	8236
M30 x 1,5	46	12	25	9000	10800
M30 x 2	46	12	25	9000	10800
M33 x 1,5	50	14	10	12375	14850
M33 x 2	50	14	10	12375	14850
M36 x 1,5	55	14	10	13500	16200
M36 x 2	55	14	10	13500	16200
M36 x 3	55	14	10	13500	16200
M39 x 1,5	60	16	LÖSA	21375	25650
M39 x 3	60	16	LÖSA	21375	25650

BEST.EX: DIN 936 STÅL M10 x 1 FZB
DATA EX: 936101001

LÅG MUTTER

VÄNSTERGÄNGAD
DIN 936
STÅL KL.04/17 H OBEH, FZB

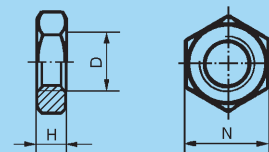

D	N	H	FÖRPACKNINGAR	PRIS KRONOR PER 100 ST.	
				OBEH	FZB
M8	13	5	100	431	518
M10	17	6	100	653	765
M12	19	7	100	878	990
M14	22	8	100	1170	1283
M16	24	8	50	1620	1778
M18	27	9	50	2093	2228
M20	30	9	50	2498	2700
M22	32	10	25	3330	3600
M24	36	10	25	4050	4500
M27	41	12	25	6863	7425
M30	46	12	10	10125	11025

BEST.EX: DIN 936 STÅL M8 OBEH VÄNSTER
DATA.EX: 936L08

LÅG MUTTER

ISO 4035
STÅL KL. 14H/04 OBEH, FZB

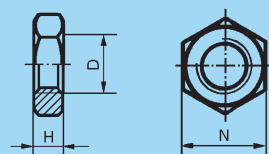

D	N	H	FÖRPACKNINGAR	PRIS KRONOR PER 100 ST.	
				OBEH	FZB
M3	5,5	1,8	1000	180	185
M4	7	2,2	1000	190	195
M5	8	2,7	1000	210	220
M6	10	3,2	500	230	240
M8	13	4,0	500	290	330
M10	16	5,0	200	425	470
M12	18	6,0	200	475	580
M14	21	7,0	200		1070
M16	24	8,0	100	1100	1390
M20	30	10,0	100	2200	2900
M24	36	12,0	50	4500	5300
M30	46	15,0	25	5900	7200
M36	55	18,0	10	6850	8400

BEST.EX: ISO 4035 STÅL M3 OBEH
DATA.EX: 40350030

TK6M

SVETSMUTTER MED STYRNINGSRING
DIN 929
STÅL OBEH

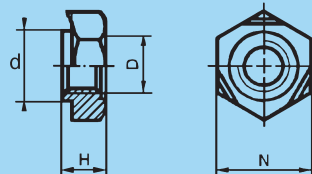

D	N	H	d	FÖRPACKNINGAR	PRIS KRONOR PER 100 ST.
M3	7,5	3	4,5	500	34
M4	9	3,5	6	500	40
M5	10	4	7	500	45
M6	11	5	8	500	52
M8	14	6,5	10,5	500	59
M10	17	8	12,5	200	99
M12	19	10	14,8	200	165
M14	22	11	16,8	100	585
M16	24	13	18,8	100	446

BEST.EX: TK6M STÅL M3
DATA.EX: 92903

TK4M

SVETSMUTTER UTAN STYRNINGSRING
DIN 928 METRISK/UNC/UNF
STÅL OBEH

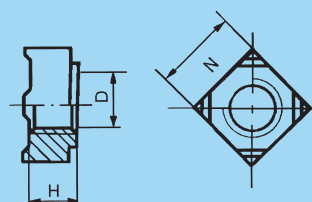

D	N	H	FÖRPACKNINGAR	PRIS KRONOR PER 100 ST.
M4	7	3,5	500	46
M5	9	4,2	500	49
M6	10	5	500	54
M8	14	6,5	500	65
M10	17	8	200	136
M12	19	9,5	200	235
M14	22	11	100	970
5/16 UNC	14	6,5	500	390
7/16 UNF	19	9	200	795

BEST.EX: TK4M M4 DIN 928
DATA.EX: 92804

FN

SVETSMUTTER MED STYRNINGSRING
ENL FABRIKSNORM 1.221
STÅL OBEH

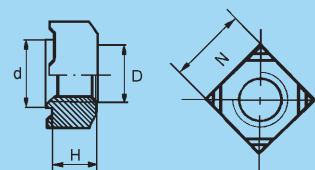

D	N	H	d	FÖRPACKNINGAR	PRIS KRONOR PER 100 ST.
M4	8	3,5	6	500	216
M5	9	4,2	7	500	176
M6	10	5	8	500	197
M8	14	6,5	11,2	500	351
M10	17	8	14	200	563
M12	19	9,5	16	200	680

BEST.EX: 4-KANTSVETSMUTTER MED STYRNINGSRING M4
DATA.EX: FN04

FK4M

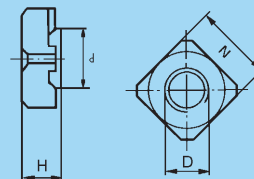

SVETSMUTTER MED STYRNINGSRING VOLVO RITN.1053291 STÅL OBEH

D	N	H	d	FÖRPACKNINGAR	PRIS KRONOR PER 100 ST.
M6	12,7	5,6	9,53	1000	285
M8	14,28	6,4	11,91	1000	360
M10	15,88	7,9	14,28	500	555
M12	20,64	11,1	17,37	200	912

BEST.EX: FK4M STÅL M6 OBEH
DATA.EX: FK4M06

SVETSMUTTER SMRP

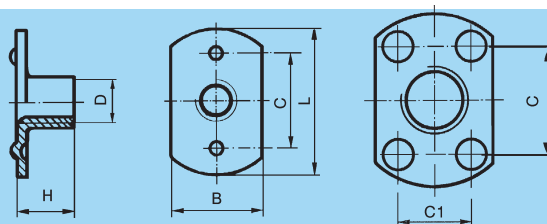

MED REKTANGULÄR PLATTA STÅL OBEH

GÅNGA	UTFÖRANDE	MUTTERLÄNGD (L)	MUTTERBREDD (B)	BUCKELAVSTÅND (C)	BUCKELAVSTÅND (C1)	MATERIALJOCKLEK	MUTTERHÖJD (H)	MUTTERDIAMETER (D)	FÖRPACKNING	PRIS KR/100 ST
M4	A	17	9,0	12		0,9	6,0	5,2	500	325
M4	B	17	9,0	12		0,9	6,0	5,2	500	325
M4	C	17	9,0			0,9	6,0	5,2	500	325
M5	A	19	11,0	14		1,3	7,5	6,1	500	410
M5	B	19	11,0	14		1,3	7,5	6,1	500	410
M5	C	19	11,0			1,3	7,5	6,1	500	410
M6	A	22	14,0	16		1,5	8,5	7,9	500	560
M6	B	22	14,0	16		1,5	8,5	7,9	500	560
M6	C	22	14,0			1,5	8,5	7,9	500	560
M8	A	26	18,0	17	10	2,0	11,0	10,4	200	800
M8	B	26	18,0	17	10	2,0	11,0	10,4	200	800
M8	C	26	18,0			2,0	11,0	10,4	200	800
M10	A	26	18,0	17	10	2,0	10,5	11,6	200	860
M10	B	26	18,0	17	10	2,0	10,5	11,6	200	860
M10	C	26	18,0			2,0	10,5	11,6	200	860
M12	A	29	20,5	17	13	2,2	12,5	13,7	100	1200
M12	C	29	20,5			2,2	12,5	13,7	100	1200

BEST.EX: SVETSMUTTER MED REKT. PLATTA STÅL M4 A
DATA.EX: SMRP04A

UTFÖRANDE:

A



B



C

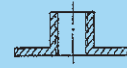

SVETSBUCKLA NEDÅT

SVETSBUCKLA UPPÅT

SLÅT FLÄNS

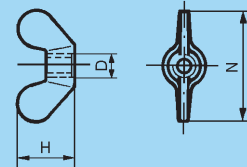
VM
**VINGMUTTER
DIN 315
ADUCERGODS OBEH, FZB**

D	N	H	FÖRPACKNINGAR	PRIS KRONOR PER 100 ST.	
				OBEH	FZB
M4	19	10	100	417	323
M5	25	12	100	531	330
M6	32	16	100	657	390
M7	32	16	100	850	900
M8	38	19	100	918	495
M10	50	24	100	1458	1090
M12	64	32	50	2466	2300
M14	68	34	50	3672	4388
M16	72	36	25	4770	3990
M20	89	45	25	11880	13275
M24	109	56	10	21420	24300

BEST.EX: VM DIN 315 ADUCERGODS M4 OBEH
DATA.EX: 31504

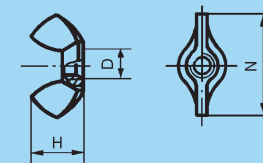
VM
**VINGMUTTER AMERIKANSK FORM
ANSI B18.17 A LIGHT (~DIN 314)
STÅL FZB**

D	N	H	FÖRPACKNINGAR	PRIS KRONOR PER 100 ST.
M3	17,6	8,6	1000	257
M4	17,6	8,6	1000	260
M5	22,5	11	1000	267
M6	27,8	13,6	500	290
M8	30,3	14,8	500	325
M10	36,2	17,7	200	839
M12	49,4	24,1	100	1932

Vi kan även leverera enl. DIN 314 mot förfrågan.

BEST.EX: VM AMERIKANSK FORM STÅL M3 FZB
DATA.EX: 314AM031

VM

METRISK/UNC/UNF
VINGMUTTER
JAPANSK FORM (~DIN 314)
STÅL FZB

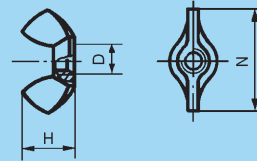

D	N	H	FÖRPACKNINGAR	PRIS KRONOR PER 100 ST.
M3	18	9	500	134
M4	22	12	500	171
M5	22	12	500	180
M6	27	14	200	229
M8	32	17	200	344
M10	37	19	100	540
M12	49	25	100	1359
No 10 UNC	22	12	500	180
1/4 UNC	27	14	200	229
5/16 UNC	32,5	17,5	200	344
3/8 UNC	37,5	19,5	100	540

Vi kan även leverera enl. DIN 314 mot förfrågan.

BEST.EX: VM JAPANSK FORM STÅL M3 FZB
DATA.EX: 314JPN031

UVM

VINGMUTTER
UNC-GÄNGA "DIN 315"
ADUCERGODS FZB

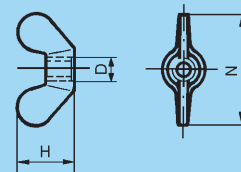

D	N	H	FÖRPACKNINGAR	PRIS KRONOR PER 100 ST.
1/4 UNC	32	16	200	1700
5/16 UNC	40	20	200	1900
3/8 UNC	50	25	100	2800
1/2 UNC	64	32	100	4600
5/8 UNC	72	36	50	6800
3/4 UNC	90	45	50	9675

BEST.EX: VM ADUCERGODS 1/4 UNC FZB
DATA.EX: 315U141

U6M

UNC-OCH UNF-GÄNGA
ANSI B 18.2.2 (SS1989-90)
STÅL OBEH, FZB, FZV

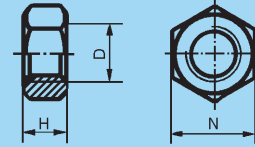

D	N (mm)	N (tum)	H	PRIS KRONOR PER 100 ST.				
				UNC-OBEH	UNC-FZB	UNC-FZV	UNF-OBEH	UNF-FZB
No 10	9,5	3/8	3,3	220	132		180	210
1/4	11,1	7/16	5,6	90	41	96	69	50
5/16	12,7	1/2	6,7	97	53	240	128	79
3/8	14,3	9/16	8,3	128	73	430	139	87
7/16	17,5		9,5	469	134	850	470	230
1/2	19	3/4	11,1	184	150	490	390	295
9/16	22,2	7/8	12,3	608	650		608	650
5/8	23,8	15/16	13,9	429	390	880	440	390
3/4	28,6	1 1/8	16,3	530	540	950	590	720
7/8	33,3	1 5/16	19,1	1100	1460	3813	2400	2900
1"	38,1	1 1/2	21,8	1490	1900	3962	2650	3300
1 1/8	42,9	1 1/2	24,6	4500	5700	9200		
1 1/4	47,6	1 7/8	27	4700	6100	9556	7200	9600
1 3/8	52,4	2 1/16	29,8	7700	9500			
1 1/2	57,2	2 1/4	32,5	7900	9900	14000	12600	16400
1 3/4	66,7	2 5/8	38,1	14000	19000	37500		
2"	76,2	3	43,7	16000	23900	49000		
2 1/4	85,7	3 3/8	48,8	99000	120000			
2 1/2	95,2	3 3/4	54,4	105000	130000			
2 3/4	104,8	4 1/8	59,9	109000	134000			
3"	114,3	4 1/2	65,5	190000	146000			

BEST.EX: U6M STÅL No 10 UNC FZB
DATA.EX: 934U101

FÖRPACKNINGAR

No10-5/16	3/8-1/2	9/16-5/8	3/4-1"	1 1/8-1 1/2	1 3/4-3"
500	200	100	50	10	LÖSA

U6M

UNC- GÄNGA VÄNSTERGÄNGAD
ANSI B 18.2.2 (SS1989-90)
STÅL OBEH, FZB

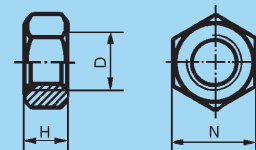

D	N (mm)	N (tum)	H	FÖRPACKNINGAR	PRIS KRONOR PER 100 ST.	
					OBEH	FZB
1/4	11,1	7/16	5,6	200	950	
5/16	12,7	1/2	6,7	200		1460
3/8	14,3	9/16	8,3	100	2900	
1/2	19	3/4	11,1	50	3500	
5/8	23,8	15/16	13,9	25	4941	6211
3/4	28,6	1 1/8	16,3	25	6850	
7/8	33,3	1 5/16	19,1	10	7900	
1"	38,1	1 1/2	21,8	10	13425	18179

BEST.EX: U6M STÅL 1/4 UNC OBEH VÄNSTER
DATA.EX: 934UL14

MHM

**KUPOLMUTTER
DIN 1587 (SS2180)
STÅL OBEH, FZB**

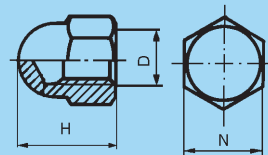

D	N	H	FÖRPACKNINGAR	PRIS KRONOR PER 100 ST.		
				OBEH	FZB	SVARVAT UTF. FZB
M3	5,5	6	500	149	155	
M4	7	8	500	149	155	
M5	8	10	500	323	275	413
M6	10	12	200	338	280	420
M8	13	15	200	420	360	540
M10	17 (16)*	18	200	590	560	840
M12	19 (18)*	22	100	1433	1250	1875
M14	22 (21)*	25	100	2400	2250	
M16	24	28	100	2138	1850	2775
M18	27	32	25	4800	4900	
M20	30	34	25	3300	3600	
M22	32 (34)*	39	10	7050	7200	
M24	36	42	10	7050	7200	

BEST.EX: MHM STÅL M3 OBEH
DATA.EX: 158703

*Nyckelvidder enligt ISO (= DIN 1587 utgåva okt 2000) kan anskaffas på begäran.

KUPOLMUTTER

**JAPANSK FORM
STÅL FZB**

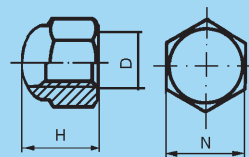

D	N	H	FÖRPACKNINGAR	PRIS KRONOR PER 100 ST.
M4	7	6,2	500	135
M5	8	7,5	500	155
M6	10	9,5	200	198
M8	13	12,5	200	356

BEST.EX: KUPOLMUTTER JPN STÅL M4 FZB
DATA.EX: 1587JPN041

UHM

**KUPOLMUTTER UNC-GÄNGA
SS 1939
STÅL FZB**

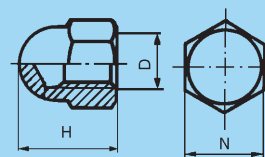

D	N (mm)	N (tum)	H	FÖRPACKNINGAR	PRIS KRONOR PER 100 ST.
no 10	9,5	3/8"	10	200	382
3/8	14,3	9/16"	18	200	1400
5/8	23,8	15/16"	30	100	5900

BEST.EX: UHM STÅL no 10 UNC FZB
DATA.EX: 1587U101

LÅSMUTTER

LÅG MODELL
DIN 985
STÅL KLASS 6 FÖRZINKAD

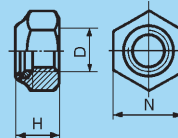

D	N	H	SMÅPACK		INDUSTRIPACK		NORMALPACK	
			FÖRP.	PRIS	FÖRP.	PRIS	FÖRP.	PRIS
M2	4,5	2,5					200	990
M2,5	5	3,8					200	257
M2,6	5	3,8					200	960
M3	5,5	4	200	29	60000	25	500	26
M3,5	6	4,5					200	865
M4	7	5	200	30	30000	26	500	27
M5	8	5	200	33	10000	29	500	30
M6	10	6	200	42	10000	35	500	36
M7	11	7,5				220	100	224
M8	13	8	200	51	5000	45	500	46
M10	17	10	100	120	2200	109	200	111
M12	19	12	100	170	1500	156	200	159
M14	22	14	50	260	1000	232	100	240
M16	24	16	50	340	750	310	100	320
M18	27	18,5	25				50	730
M20	30	20	25	770	400	729	50	740
M22	32	22					25	1500
M24	36	24			200	1510	25	1560
M27	41	27					10	4850
M30	46	30					10	4900
M33	50	33					10	11129
M36	55	36					10	12990
M39	60	39					LÖSA	37848
M42	65	42					LÖSA	39000
M45	70	45					LÖSA	65000
M48	75	48					LÖSA	94000

BEST.EX: LÅSMUTTER DIN 985 KLASS 6 M2 FZB
DATA.EX: 9850201

OM EJ ANNAT ANGES LEVERERAS NORMALPACK.

LÅSMUTTER

LÅG MODELL
DIN 985
STÅL KLASS 8 FÖRZINKAD

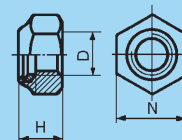

D	N	H	FÖRPACKNINGAR	PRIS KRONOR PER 100 ST.
M4	7	5	500	40
M5	8	5	500	41
M6	10	6	500	54
M8	13	8	500	59
M10	17	10	200	156
M12	19	12	200	198
M14	22	14	100	350
M16	24	16	100	420
M18	27	18,5	50	850
M20	30	20	50	990
M22	32	22	25	1900
M24	36	24	25	1990
M27	41	27	10	6900
M30	46	30	10	7200
M36	55	36	10	14300
M39	60	39	10	39800

BEST.EX: LÅSMUTTER DIN 985 KLASS 8 M4 FZB
DATA.EX: 98580401

OM EJ ANNAT ANGES LEVERERAS NORMALPACK.

LÅSMUTTER

HÖG MODELL
DIN 982
STÅL KLASS 8 FÖRZINKAD

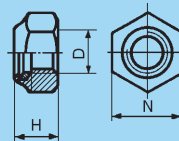

D	N	H	FÖRPACKNINGAR		PRIS KRONOR PER 100 ST.	
			NORMALPACK	INDUSTRIPACK	NORMALPACK	INDUSTRIPACK
M4*	7	5	500		59	
M5	8	6,3	500		39	
M6	10	8	500	8000	44	43
M8	13	9,5	500	4000	64	63
M10	17	11,5	200	2000	130	128
M12	19	14	200	1200	179	176
M14	22	16	100	900	395	385
M16	24	18	100	600	430	420
M18	27	20	100		890	
M20	30	22	100		895	875
M22	32	25	25		2900	
M24	36	28	25		2990	
M30*	46	33	10		9900	
M36*	55	36	10		14900	

BEST.EX: DIN 982 KLASS 8 M4 FZB
DATA.EX: 982041

OM EJ ANNAT ANGES LEVERERAS NORMALPACK.
* Ingår inte i DIN 982

LÅSMUTTER

HÖG MODELL
DIN 6924 (ISO 7040)
STÅL KLASS 8 FÖRZINKAD

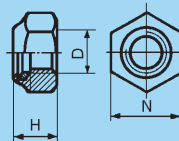

D	N	H	FÖRPACKNINGAR	PRIS KRONOR PER 100 ST.
M4	7	6	500	49
M5	8	6,8	500	55
M6	10	8	500	62
M8	13	9,5	500	85
M10	16	11,9	200	139
M12	18	14,9	200	198
M14	21	17	100	590
M16	24	19,1	100	595
M20	30	22,8	50	1210
M24	36	27,1	25	3700

BEST.EX: DIN 6924 KLASS 8 M4 FZB
DATA.EX: 6924041

LÅSMUTTER

LÅG MODELL
DIN 985 FINGÄNGAD
STÅL KLASS 6 FÖRZINKAD

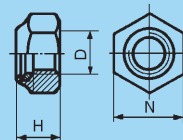

D	N	H	FÖRPACKNINGAR	PRIS KRONOR PER 100 ST.
M8 x 1	13	8	200	585
M10 x 1	17	10	200	935
M10 x 1,25	17	10	200	935
M12 x 1	19	12	200	1305
M12 x 1,25	19	12	200	1305
M12 x 1,5	19	12	200	1305
M14 x 1,5	22	14	100	2273
M16 x 1,5	24	16	100	2813
M18 x 1,5	27	18,5	50	3218
M18 x 2	27	18,5	50	3218
M20 x 1,5	30	20	50	4230
M20 x 2	30	20	50	4230
M22 x 1,5	32	22	25	6300
M22 x 2	32	22	25	6300
M24 x 1,5	36	24	25	7313
M24 x 2	36	24	25	7313
M27 x 2	41	27	25	13500
M30 x 2	46	30	10	16875
M33 x 2	50	33	10	26325
M36 x 3	55	36	10	33975
M39 x 3	60	39	LÖSA	45000
M42 x 3	65	42	LÖSA	83250
M45 x 3	70	45	LÖSA	84975
M48 x 3	75	48	LÖSA	100125

BEST.EX: LÅSMUTTER DIN 985 STÅL M8 x 1 FZB
DATA.EX: 985081001

LÅSMUTTER

LÅG MODELL
DIN 985 FINGÄNGAD
STÅL KLASS 10 FÖRZINKAD

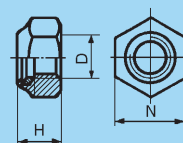

D	N	H	FÖRPACKNINGAR	PRIS KRONOR PER 100 ST.
				FZB
M8 x 1	13	8	200	878
M10 x 1	17	10	200	1403
M12 x 1,25	19	12	200	1958
M12 x 1,5	19	12	200	1958
M14 x 1,5	22	14	100	3410
M16 x 1,5	24	16	100	4220
M18 x 1,5	27	18,5	50	4827
M20 x 1,5	30	20	50	6345
M20 x 2	30	20	50	6345
M22 x 1,5	32	22	25	9450
M24 x 1,5	36	24	25	10970
M24 x 2	36	24	25	10970
M30 x 2	46	30	10	25310

BEST.EX: LÅSMUTTER DIN 985 STÅL KLASS 10 M8 x 1 FZB
DATA.EX: 98510081001

LÅSMUTTER

LÅG MODELL
DIN 985
STÅL KLASS 10 FÖRZINKAD

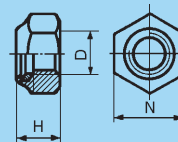

D	N	H	FÖRPACKNINGAR	PRIS KRONOR PER 100 ST.
M5	8	5	500	552
M6	10	6	500	585
M8	13	8	500	833
M10	17	10	200	1125
M12	19	12	200	1620
M14	22	14	100	2565
M16	24	16	100	3015
M18	27	18,5	50	3488
M20	30	20	50	5625
M22	32	22	25	7900
M24	36	24	25	8325
M27	41	27	25	9900
M30	46	30	10	16000
M36	55	36	10	19400

BEST.EX: DIN 985 KLASS 10 M5 FZB
DATA.EX: 98510051

LÅSMUTTER

HÖG MODELL
DIN 6924 (ISO 7040)
STÅL KLASS 10 FÖRZINKAD

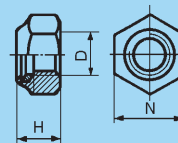

D	N	H	FÖRPACKNINGAR	PRIS KRONOR PER 100 ST.
M5	8	6,8	500	115
M6	10	8	500	120
M8	13	9,5	500	135
M10	16	11,9	200	285
M12	18	14,9	200	385
M14	21	17	100	958
M16	24	19,1	100	2500
M18	27	20,6	50	2750
M20	30	22,8	50	2850
M22	34	24,5	25	3250
M24	36	27,1	25	3900

BEST.EX: DIN 6924 KLASS 10 M5 FZB
DATA.EX: 692410051

LÅSMUTTER

HELMETALLISK
DIN 980-V
STÅL KLASS 8 FÖRZINKAD

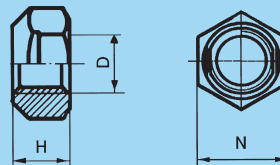

D	N	H	FÖRPACKNINGAR	PRIS KRONOR PER 100 ST.
M4	7	4,2	500	99
M5	8	5,1	500	95
M6	10	6	500	41
M8	13	8	500	69
M10	17	10	200	158
M12	19	12	200	230
M14	22	14	100	390
M16	24	16	100	544
M18	27	18	50	2950
M20	30	20	50	3200
M24	36	24	25	4500
M27	41	27	25	5834
M30	46	30	25	9594

BEST.EX: LÅSMUTTER DIN 980 KLASS 8 M4 FZB
DATA.EX: 980041

LÅSMUTTER

FINGÄNGAD, HELMETALLISK
DIN 980-V
STÅL KLASS 8 FÖRZINKAD

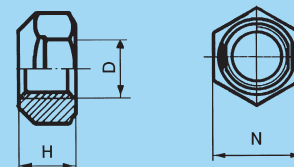

D	N	H	FÖRPACKNINGAR	PRIS KRONOR PER 100 ST.
M8 x 1	13	8	500	339
M10 x 1,25	17	10	200	735
M12 x 1,25	19	12	200	927
M12 x 1,5	19	12	200	927
M14 x 1,5	22	14	100	1356
M16 x 1,5	24	16	100	1698
M18 x 1,5	27	18	50	3500
M20 x 1,5	30	20	50	3900
M22 x 1,5	32	22	25	6500
M24 x 2	36	24	25	6900
M30 x 2	46	30	25	11200
M36 x 3	55	36	10	16000

BEST.EX: LÅSMUTTER DIN 980 FINGÄNGAD KLASS 8 M8 x 1 FZB
DATA.EX: 9808081001

LÅSMUTTER

HELMETALLISK
DIN 6925 (~ISO 7042)
STÅL KLASS 8 FÖRZINKAD

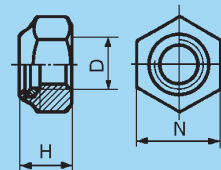

D	N	H	FÖRPACKNINGAR	PRIS KRONOR PER 100 ST.
M5	8	5,1	500	65
M6	10	6	500	69
M8	13	8	500	133
M10	16	10	200	210
M12	18	12	200	349
M14	21	14	50	1400
M16	24	16	100	670
M18	27	18	50	3200
M20	30	20	50	1900
M24	36	24	25	3100
M27	41	27	25	12400
M30	46	30	25	16800

BEST.EX: HELMETALLISK LÅSMUTTER DIN 6925 STÅL KLASS 8 M5 FZB
DATA.EX: 6925051

FLÄNSLÅSMUTTER

MED PLASTINSATS
DIN 6926 (ISO 7043)
STÅL KLASS 8 FÖRZINKAD

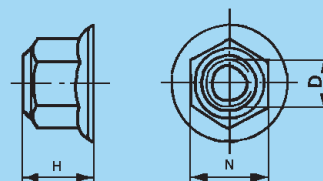

D	N	H	FÖRPACKNINGAR	PRIS KRONOR PER 100 ST.
M5	8	7,1	200	115
M6	10	9,1	200	116
M8	13	11,1	200	162
M10	15	13,5	100	281
M12	18	16,1	100	466
M16	24	20,3	50	995
M20	30	24,8	25	2700

BEST.EX: FLÄNSLÅSMUTTER DIN 6926 STÅL KLASS 8 M5 FZB
DATA.EX: 6926051

FLÄNSLÅSMUTTER

HELMETALLISK
DIN 6927 (ISO 7044)
STÅL KLASS 8 FÖRZINKAD

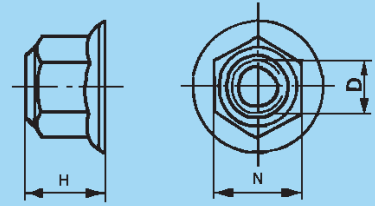

D	N	H	FÖRPACKNINGAR	PRIS KRONOR PER 100 ST.
M5	8	6,2	500	170
M6	10	7,3	200	175
M8	13	9,4	200	196
M10	15	11,4	100	290
M12	18	13,8	100	529
M16	24	18,3	50	2200

BEST.EX: FLÄNSLÅSMUTTER DIN 6927 STÅL KLASS 8 M6 FZB
DATA.EX: 6927051

LÅSMUTTER

HELMETALLISK MED FJÄDRANDE LÅSBRICKA
DIN 980-M
STÅL KLASS 8 VARMFÖRZINKAD

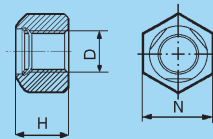

D	N	H	FÖRPACKNINGAR	PRIS KRONOR PER 100 ST.
M8	13	8	100	3300
M10	17	10	100	3750
M12	19	12	100	4350
M16	24	16	50	7650
M20	30	20	25	22200
M24	36	22	25	31500

BEST.EX: LÅSMUTTER DIN 980 HELMETALLISK STÅL KLASS 8 M8 FZV
DATA.EX: 980M082

KUPOLLÅSMUTTER

DIN 986
STÅL KLASS 6 FÖRZINKAD

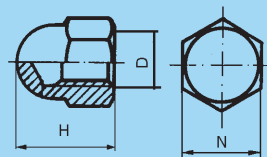

D	N	H	FÖRPACKNINGAR	PRIS KRONOR PER 100 ST.
M4	7	9,6	500	434
M5	8	10,5	500	492
M6	10	12	500	510
M8	13	14	200	804
M10	17 (16)*	18,1	200	1278
M12	19 (18)*	22,5	100	1800
M16	24	27,5	50	2268
M20	30	35	50	7900

BEST.EX: KUPOLLÅSMUTTER DIN 986 STÅL M4 FZB
DATA.EX: 986041

*Nyckelvidd enligt ISO (= Din 986 utgåva feb 2000) kan anskaffas på begäran.

LÅSMUTTER

UNC, UNF
MED PLASTINSATS
IFI 100
STÅL FÖRZINKAD

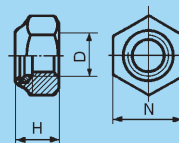

D	N (mm)	N (tum)	H	FÖRPACKNINGAR	PRIS KRONOR PER 100 ST.	
					UNC	UNF
No10	9,5	3/8	6,1	200	560	
1/4	11,1	7/16	8,3	200	65	129
5/16	12,7	1/2	9,1	200	94	148
3/8	14,3	9/16	11,9	200	138	230
7/16	17,5	11/16	13,3	200		582
1/2	19	3/4	15,5	100	259	590
9/16	22,2	7/8	16,7	50	990	
5/8	23,8	15/16	19,4	50	750	750
3/4	28,6	1 1/8	22,6	50	1766	2400
7/8	33,3	1 5/16	25,4	25	6500	6500
1"	38,1	1 1/2	28,6	25	7471	7471
1 1/4	47,6	1 7/8	36,9	10	22560	22560
1 1/2	57,2	2 1/4	42,4	10		54335

BEST.EX: LÅSMUTTER STÅL IFI 100 No 10 UNC FZB
DATA.EX: 982U101

FLÄNSMUTTER

DIN 6923 (SS-ISO 4161)
STÅL KL 8 FÖRZINKAD

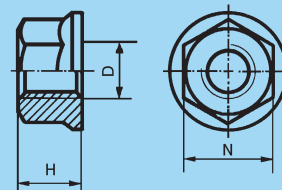

D	N	H	FÖRPACKNINGAR	PRIS KRONOR PER 100 ST.
M4	7	5	500	90
M5	8	5	500	49
M6	10	6	500	58
M8	13	8	200	78
M10	15	10	200	149
M12	18	12	200	232
M16	24	16	100	695
M20	30	20	50	2759

BEST.EX: FLÄNSMUTTER DIN 6923 STÅL KL 8 M4 FZB
DATA.EX: 69238041

FLÄNSMUTTER

MED LÅS-TÄNDER
TENSIFLÄNS (~DIN 6923 SS-ISO 4161)
STÅL KL 8 FÖRZINKAD

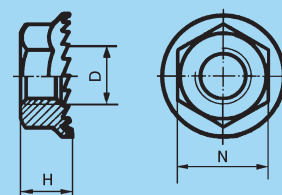

D	N	H	FÖRPACKNINGAR	PRIS KRONOR PER 100 ST.
M4	7	5	500	90
M5	8	5	500	49
M6	10	6	500	58
M8	13	8	200	78
M10	15	10	200	149
M12	18	12	200	232
M14	21	14	100	990
M16	24	16	100	990

BEST.EX: TENSIFLÄNS DIN 6923 STÅL KL 8 M4 FZB
DATA.EX: 6923Z8041

M6MF

HÖG
FABRIKSNORM
STÅL KL 8 OBEH/FÖRZINKAD

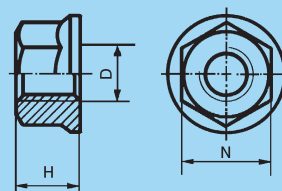

D	N	H	FÖRPACKNINGAR	PRIS KRONOR PER 100 ST. FZB
M6*	10	8,2	200	560
M16*	24	18,9	50	6600
M20*	30	20	50	17800

BEST.EX: M6MF HÖG STÅL M6 FZB
DATA.EX: M6MFH061

*OBS! Kommer att utgå!

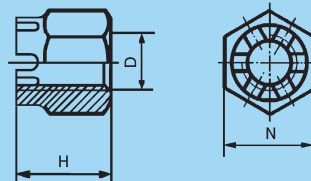
MKM**KRONMUTTER
DIN 935-1
STÅL KL 6 OBEH, FZB**

D	N	H	FÖRPACKNINGAR	PRIS KRONOR PER 100 ST.	
				OBEH	FZB
M4	7	5	100	790	850
M5	8	6	100	790	850
M6	10	7,5	100	801	870
M8	13	9,5	100	810	880
M10	17 (16)*	12	100	864	1575
M12	19 (18)*	15	100	1350	1875
M14	22 (21)*	16	50	2088	1950
M16	24	19	50	2106	2300
M18	27	21	25	3240	3600
M20	30	22	25	3834	3980
M22	32 (34)*	26	25	4860	5175
M24	36	27	25	6300	6800
M27	41	30	10	9360	9900
M30	46	33	10	11880	12700
M33	50	35	LÖSA	15840	19125
M36	55	38	LÖSA	21060	24900
M39	60	40	LÖSA	26280	28125
M42	65	46	LÖSA	35280	37125
M45	70	48	LÖSA	42840	45000
M48	75	50	LÖSA	72000	74250
M52	80	54	LÖSA	85500	90000
M56	85	57	LÖSA	123750	130500
M60	90	63	LÖSA	144000	153000
M64	95	66	LÖSA	175500	184500
M68	100	69	LÖSA	339750	351000
M72 x 6	105	73	LÖSA	371250	382500
M76 x 6	110	76	LÖSA	436500	447750
M80 x 6	115	79	LÖSA		378750
M90 x 6	130	92	LÖSA		547500
M100 x 6	145	100	LÖSA	730500	757500

BEST.EX: MKM STÅL M4 OBEH
DATA.EX: 935004

*Nyckelvidd enligt ISO (= DIN 935 utgåva okt 2000)
kan anskaffas på begäran.

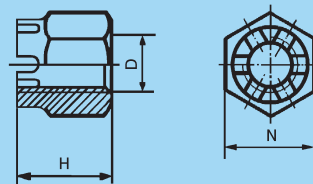
MKM**KRONMUTTER
DIN 935-1 FINGÄNGAD
STÅL KL 6 FZB**

M8 x 1	13	9,5	100	1647
M10 x 1,25	17 (16)*	12	100	2601
M12 x 1,25	19 (18)*	15	100	3726
M14 x 1,5	22 (21)*	16	50	4230
M16 x 1,5	24	19	50	4338
M18 x 1,5	27	21	25	5472
M20 x 1,5	30	22	25	7200
M22 x 1,5	32 (34)*	26	25	9180
M24 x 2	36	27	25	11700
M30 x 2	46	33	10	21185
M36 x 3	55	38	LÖSA	52875

BEST.EX: MKM STÅL M8 x 1 FZB
DATA.EX: 935081001

*Nyckelvidd enligt ISO (= DIN 935 utgåva okt 2000)
kan anskaffas på begäran.

4-KANTSMUTTER

HÖG
DIN 557
STÅL OBEH, FZB

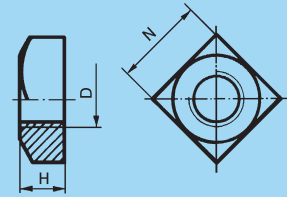

D	N	H	FÖRPACKNINGAR	PRIS KRONOR PER 100 ST.	
				OBEH	FZB
M5	8	4	500	185	126
M6	10	5	500	212	143
M8	13	6,5	200	309	284
M10*	17 (16)*	8	100	527	563
M12	19 (18)*	10	100	720	912
M16	24	13	50	1418	2168
M20	30	16	50		3510

BEST.EX: DIN 557 STÅL M5 OBEH
DATA.EX: 55705

*Nyckelvidd enligt ISO 272 kan anskaffas på begäran

4-KANTSMUTTER

LÅG
DIN 562
STÅL OBEH, FZB

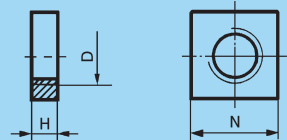

D	N	H	FÖRPACKNINGAR	PRIS KRONOR PER 100 ST.	
				OBEH	FZB
M2	4	1,2	100	117	59
M2,5	5	1,6	100		57
M3	5,5	1,6	1000	117	44
M3,5	6	2	100		63
M4	7	2	1000	125	45
M5	8	2,5	500	144	66
M6	10	3	500	162	116
M8	13	4	200	261	207
M10	17 (16)*	5	100	408	428

BEST.EX: DIN 562 STÅL M2 OBEH
DATA.EX: 562020

*Nyckelvidd enligt DIN 562 utgåva febr 2000 kan anskaffas på begäran.

6-KANTSMUTTER

LÅG
W-GÄNGA
STÅL FZB

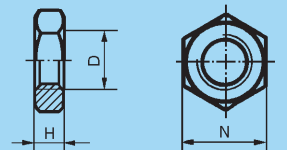

D	N	H	FÖRPACKNINGAR	PRIS KRONOR PER 100 ST.
3/16	9	3	1000	264
1/4	11	3,5	1000	428

BEST.EX: 6-KANTMUTTER STÅL W3/16 x 9 x 3 FZB
DATA.EX: 439W3161

M6HM

SKARVMUTTER
(SS 2178)
STÅL OBEH, FZB

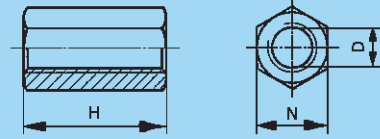

D	N	H	FÖRPACKNINGAR	PRIS KRONOR PER 100 ST.	
				OBEH	FZB
M6	10	50	200	900	950
M8	13	50	200	950	1020
M10	17	50	100	990	1150
M12	19	50	100	1200	1400
M14	22	50	50		2900
M16	24	50	50	1800	2300
M20	30	50	50	3400	3800
M24	36	50	50	4900	5700

BEST.EX: M6HM SKARVMUTTER STÅL M6 OBEH
DATA.EX: M6HM06

DIN 6334

SKARVMUTTER
STÅL FÖRZINKAD

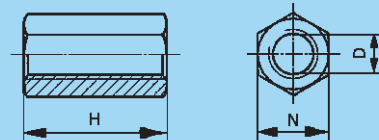

D	N	H	FÖRPACKNINGAR	PRIS KRONOR PER 100 ST.	
				OBEH	FZB
M6	10	18	200	300	310
M8	13	24	200		320
M10	17	30	100	590	600
M12	19	36	100	1170	1200
M16	24	48	50		2460
M20	30	60	25		13740
M24	36	72	LÖSA		19000
M27	41	81	LÖSA		20000

BEST.EX: DIN 6334 SKARVMUTTER STÅL M6 FZB
DATA.EX: 6334061

U6HM

UNC-GÄNGA
SKARVMUTTER
STÅL OBEH



D	N (mm)	N (tum)	H	FÖRPACKNINGAR	PRIS KRONOR PER 100 ST. OBEH
3/8	14,3	9/16	50	100	3162

BEST.EX: U6HM SKARVMUTTER STÅL 3/8 UNC OBEH
DATA.EX: U6HM38

6-KANTMUTTER

DIN 6330, FORM A OCH B
STÅL KL. 6/10

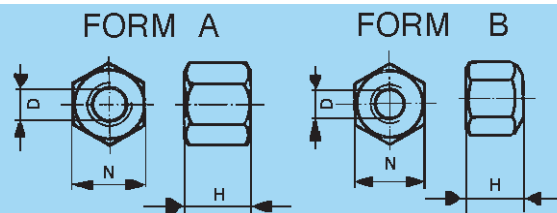

D	N	H	FÖRPACKNINGAR	PRIS KRONOR PER 100 ST.		
				FORM A KLASS 6	FORM B KLASS 6	FORM B KLASS 10
M8	13	12	100	650	650	1330
M10	16	15	100	730	730	1610
M12	18	18	50	850	850	2240
M14	22	21	25	1200	2700	3850
M16	24	24	25	1400	1400	
M18	27	27	25	7600	4905	6650
M20	30	30	25	4500	4500	8750
M22	32	33	25	6900	6900	10500
M24	36	36	10	7800	7800	12600
M27	41	40	LÖSA	13275	13275	21000
M30	46	45	LÖSA	17775	17775	28000
M36	55	54	LÖSA			47600

BEST.EX: DIN 6330 A STÅL M8
DATA.EX: 6330A608

KRAGMUTTER

DIN 6331
STÅL KLASS 10

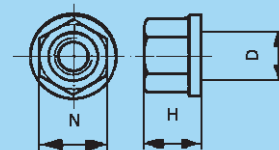

D	N	H	FÖRPACKNINGAR	PRIS KRONOR PER 100 ST.
M8	13	12	50	3735
M10	16	15	50	5738
M12	18	18	25	6863
M14	22	21	10	13500
M16	24	24	10	11250
M18	27	27	LÖSA	14850
M20	30	30	LÖSA	14850
M22	32	33	LÖSA	30375
M24	36	36	LÖSA	27225
M27	41	40	LÖSA	65250
M30	46	45	LÖSA	46350

BEST.EX: KRAGMUTTER KLASS 10 M8
DATA.EX: 63311008

ISLAGSMUTTER

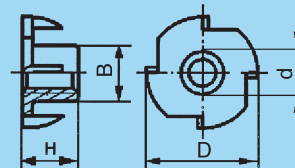

STÅL OBEH, FZB

d	D	H	B	FÖRPACKNINGAR	PRIS KRONOR PER 100 ST.	
					OBEH	FZB
M3	13	5,3	3,8	500	503	507
M4	15	8	5,3	500	75	77
M5	17	8	6,2	500	113	117
M6	19	9	7,7	500	117	120
M8	22	11	9,5	200	156	173
M10	25,5	13	12	200	282	398
M12	27	15	14	200		1960

BEST.EX: ISLAGSMUTTER STÅL M3 OBEH
DATA.EX: TN03

Vissa dimensioner kan tillhandahållas med annan höjd.

LÄTTRADE MUTTRAR

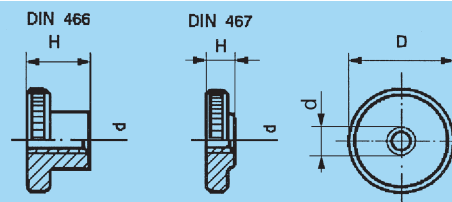

DIN 466 OCH 467
STÅL KL. 5 FZB

d	D	H		FÖRPACKNINGAR	PRIS KRONOR PER 100 ST.	
		DIN 466	DIN 467		DIN 466	DIN 467
M2	9	5,3	2,5	100	1790	1790
M2,3	10	6	3	100	2465	2465
M2,5	11	6,5	3	100	2633	2465
M2,6	11	7	3	100	2633	2465
M3	12	7,5	3	100	504	417
M3,5	14	8,5	3,5	100	1553	1553
M4	16	9,5	4	100	797	756
M5	20	11,5	5	100	1229	851
M6	24	15	6	100	2127	1364
M8	30	18	8	50	3578	2565
M10	36	23	10	50	5900	4199

BEST.EX: DIN 466 STÅL LÄTTRAD M2 FZB
DATA.EX: 4660201

KORGMUTTRAR

STÅL
SMG FÖRZINKAD

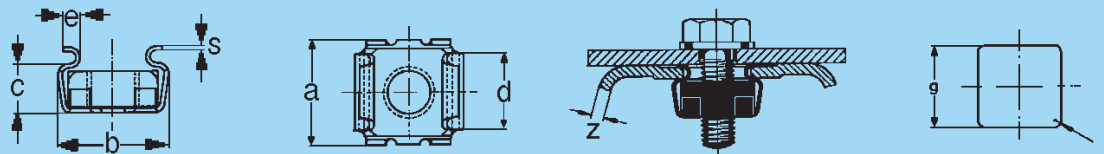
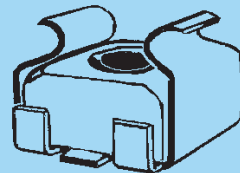

PANEL											PRIS KR.
GÄNGA	KOD	a	b	c	d	e	s	g-0,5	r	z	PER 100 ST.
M4	4	13,1	13,5	4,6	8,7	2,3	0,5	9,5	0,8	0,7-1,7	327
M5	6	13,4	13,9	6,4	8,8	2,3	0,5	9,5	0,8	0,7-1,7	306
M6	6	13,4	13,9	6,4	8,8	2,3	0,5	9,5	0,8	0,7-1,7	327
M8	6	16,6	17,8	7,4	11,4	3,4	0,6	12,5	1,2	0,7-1,7	491
M4	8	13,1	13,5	4,6	8,7	2,3	0,5	9,5	0,8	1,8-2,6	327
M5	8	13,1	13,7	6,3	8,8	2,3	0,5	9,5	0,8	1,8-2,6	306
M6	8	13,1	13,7	6,3	8,8	2,3	0,5	9,5	0,8	1,8-2,6	327
M8	8	16,6	17,8	7,4	11,4	3,4	0,6	12,5	1,2	1,8-2,6	491
M10	8	16,6	17,8	7,4	11,4	3,4	0,6	12,5	1,2	1,8-2,6	816

BEST.EX: KORGMUTTER SMG M4-4 FZB **DATA.EX:** SMG441 **FÖRPACKNINGAR:** 1000 ST.

MC/SMC

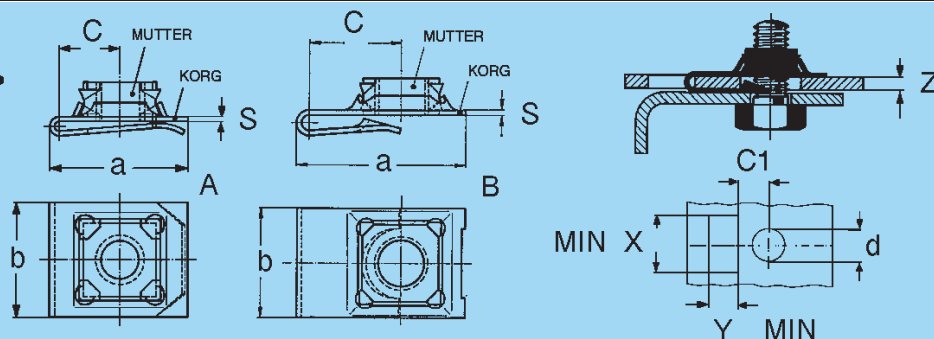

STÅL
GULKROM

TYP	GÄNGA	a	b	c	s	c1	d	x	y	z	UTF	PRIS KR.
												PER 100 ST.
MC5648	M4	17,1	12,0	8,0	0,6	8,0	6,0	12,4	8,5	1,7-2,8	A	1000
SMC6238	M5	23,0	16,0	11,5	1,5	11,5	8,0	16,4	-	3,0-3,4	B	1350
MC5678	M6	17,1	14,0	7,0	0,6	7,0	8,0	14,4	-	2,2-3,0	A	1100
SMC5535	M6	24,5	15,8	13,3	0,7	13,3	10,2	16,2	8,0	0,7-2,0	B	1350
MC5988	M8	26,5	18,0	14,9	0,7	14,9	10,2	18,4	8,0	0,7-2,0	A	1350

BEST.EX: KORGMUTTER MC 5648 M8 GK **DATA.EX:** MC56483 **FÖRPACKNINGAR:** 1000 ST.

CV

STÅL
FÖRZINKAD

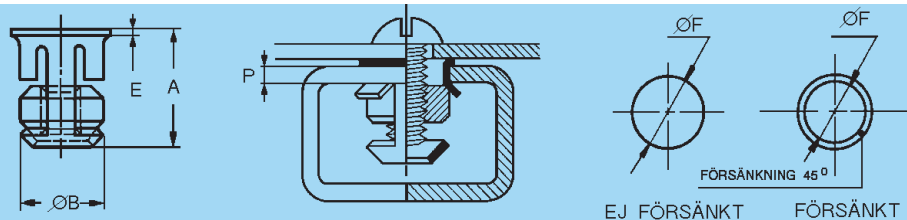

GÄNGA Ø mm	P=PLÅTTJOCKLEK mm		FÖRSÄNKNING NR	DETALJ	A	Ø B ±0,1	E	Ø F	PRIS KR. PER 100 ST.
	EJ FÖRSÄNKT	FÖRSÄNKT							
M4	0,7-3	1,2-3,5	0,75	CV4822	9,2	7	0,5	7,2	1100
M4	0,7-4	1,5-5	1	CV4824	13	9,9	0,6	10,1	1150
M5	0,7-4	1,5-5	1	CV4825	13	9,9	0,6	10,1	1250
M6	0,7-4	1,5-5	1	CV4826	13	9,9	0,6	10,1	1300
M8	1,0-6	1,8-7	1,5	CV4828	18,2	12,9	0,9	13,2	1550

BEST.EX: KORGMUTTER CV 4822 M4 FZB **DATA.EX:** CV4822 **FÖRPACKNINGAR:** 1000 ST.

SNU

SNABBLÅSMUTTER FÖR PLÅTSKRUV STÅL OBEH, FZB

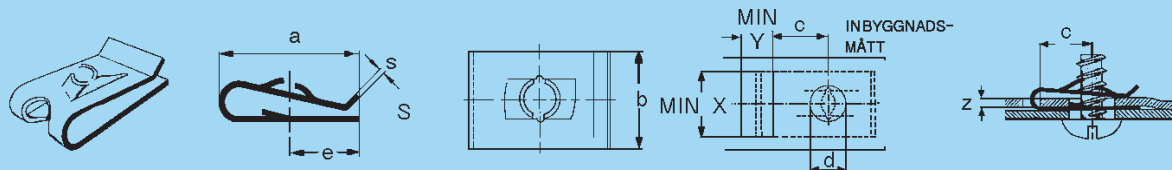

PRIS KR PER 100 ST.

SKRUV	z	DET.NR.	a	b	c	e	s	d	x	y	UTF	OBEH	FZB
2,9	0,7-1,2	SNU 1812 N	11,1	7,9	4,8	5,0	0,5	4,8	8,3	5,5	S	93	
3,5	0,7-1,6	SNU 1219 G	16,4	11,0	6,7	7,9	0,6	6,0	11,4	6,1	D		134
4,2	0,6-1,0	SNU 1864 G	13,9	12,7	5,6	6,4	0,6	7,2	13,0	6,4	F		134
4,2	0,8-1,2	SNU 5814 G	15,1	10,3	8,4	5,6	0,5	5,0	-	-	A		174
4,2	0,7-1,6	SNU 1561 N	24,6	11,1	15,0	7,9	0,6	7,2	11,4	10,7	D	174	
4,2	0,7-1,6	SNU 0536 G	16,5	11,0	6,7	7,9	0,6	7,2	11,4	7,6	D	113	
4,2	1,2-1,6	SNU 1686 G	13,9	12,7	5,6	6,4	0,6	7,2	13,0	7,1	F		134
4,2	1,6-2,0	SNU 6601 G	10,4	8,7	4,2	4,5	0,6	6,6	-	-	A		134
4,2	2,0-2,8	SNU 2569 G	16,3	11,1	6,7	7,9	0,6	7,2	11,4	7,6	D		266
4,2	3,2-3,6	SNU 1907 G	17,2	11,1	6,8	7,9	0,6	6,4	-	-	B		174
4,2	4,0-5,0	SNU 5219 G	16,4	11,1	5,3	7,9	0,6	6,4	-	-	B		204
4,8	0,9-1,6	SNU 3275 G	12,2	16,0	5,5	3,5	0,7	8,0	-	-	E		123
4,8	0,9-2,0	SNU 0537 G	19,8	12,7	7,9	9,6	0,7	8,0	12,9	9,4	S		144
4,8	3,0-3,8	SNU 5270 G	20,0	16,0	8,0	9,3	0,7	8,0	-	-	J		225
4,8	6,0-6,4	SNU 2012 G	22,2	17,5	10,3	7,9	0,7	8,0	-	-	F		306
5,5	0,9-2,6	SNU 0538 N	26,2	15,1	11,1	12,4	0,8	10,0	15,4	9,9	D	204	
5,5	3,0-3,5	SNU 5508 G	26,2	15,1	11,1	12,4	0,8	10,0	-	-	D		306
6,3	2,3-2,8	SNU 6527 G	16,7	19,0	7,9	6,6	0,9	9,5	-	-	J		234
6,3	0,7-2,0	SNU 6304 G	25,0	15,0	12,5	10,5	0,8	8,7	15,5	14,0	S		306

BEST.EX: SNABBLÅSMUTTER SNU 1812
DATA.EX: SNU1812

FÖRPACKNINGAR: 1000 ST

BUFAB

SNJ

SNABBLÅSMUTTER FÖR PLÅTSKRUV STÅL GK

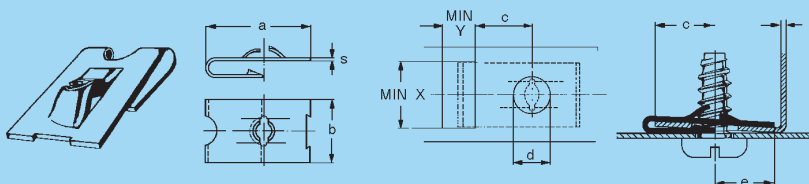

SKRUV z	DET.NR.	a	b	c	e	s	d	x	y	PRIS KRONOR PER 100 ST.
3,5 1,2-1,6	SNJ 1198/6 G	16,6	11,1	7,1	8,0	0,6	6,1	11,4	4,1	300
3,5 2,4-2,6	SNJ 5681 G	16,6	9,7	6,3	8,1	0,6	6,4	10,3	6,4	280
4,2 0,7-1,2	SNJ 0116/5 G	16,7	11,1	7,1	8,0	0,6	7,1	11,4	5,6	280
4,2 1,4-1,8	SNJ 0116/6 G	16,6	11,1	7,1	8,0	0,6	7,1	11,4	5,6	300
4,8 0,7-1,2	SNJ 0117/5 G	19,8	12,7	8,9	9,3	0,7	7,9	13,0	6,4	350

BEST.EX: SNABBLÅSMUTTER SNJ 1198/6 GK
DATA.EX: SNJ119863

FÖRPACKNINGAR: 1000 ST.

SNP

SNABBLÅSMUTTER FÖR METRISK PLÅTSKRUV STÅL OBEH, GK

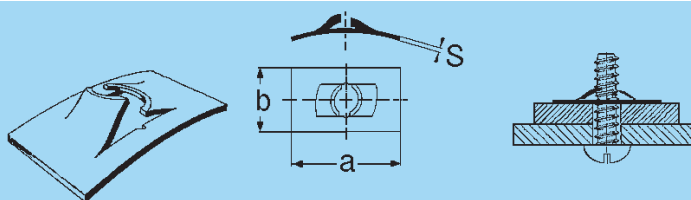

SKRUV	DET.NR.	a	b	s	PRIS KRONOR PER 100 ST.	
					OBEH	GK
4,2	SNP 0176 G	15,2	9,5	0,6	250	300
4,8	SNP 0177 G	16,7	10,3	0,7		250
5,5	SNP 0178 N	17,5	11,1	0,8	123	220
M4	SNP 5021 G	12,0	8,7	0,4		
M5	SNP 5367 N	16,7	10,3	0,4		
M6	SNP 5373 N	17,5	11,1	0,5	134	

BEST.EX: SNABBLÅSMUTTER SNP 0176 GK
DATA.EX: SNP01763

FÖRPACKNINGAR: 1000 ST

NU

SNABBLÅSMUTTER FÖR PLÅTSKRUV STÅL OBEH

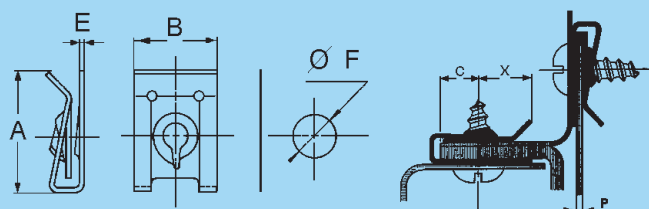

GÄNGA Ø mm	P=PLÅT- TJOCKLEK mm	DETALJ NR	A	B	X	C MAX	E	F	PRIS KRONOR PER 100 ST.
Ø 3,5	0,5-4	NU 923 N	20	14	10	8,8	0,5	6	850
Ø 4,2	0,5-4	NU 920 N	20	14	10	8,8	0,5	7	1050
Ø 4,8	0,5-4	NU 921 N	20	14	10	8,8	0,6	7	830

BEST.EX: SNABBLÅSMUTTER NU 923 N
DATA.EX: NU923

FÖRPACKNINGAR: 1000 ST.

NUT

SNABBLÅSMUTTER FÖR METRISK
SKRUV
STÅL FZB

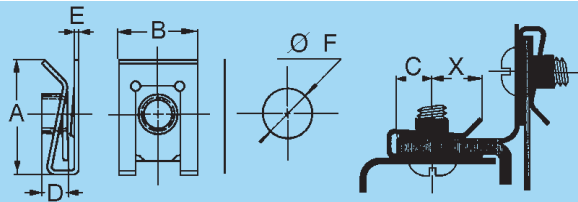

GÄNGA Ø mm	P=PLÅT- TJOCKLEK mm	DETALJ NR	A	B	D	X	C MAX	E	F	PRIS KRONOR PER 100 ST.
M5	0,5-4	NUT 955	20,4	14	5,2	9	10	0,6	7,5	918
M6	0,5-4	NUT 956	20,4	15	6,5	10	11	0,7	8,5	969
M8	0,5-4	NUT 958	24,6	17	7,5	9,8	12	1,0	11,6	1122

BEST.EX: SNABBLÅSMUTTER NUT 955
DATA.EX: NUT955

FÖRPACKNINGAR: 1000 ST

BUFAB

DISTANSMUTTER

6-KANT
STÅL FZB



D	H	N	FÖRPACKNINGAR	PRIS KRONOR PER 100 ST
M5	10	8	200	536
M5	15	8	200	612
M5	20	8	200	725
M5	25	8	200	779
M6	10	10	200	549
M6	15	10	200	639
M6	20	10	100	734
M6	25	10	100	788
M6	30	10	100	927
M6	35	10	100	1152
M6	40	10	100	1260
M6	50	10	100	2286
M8	15	13	100	878
M8	20	13	100	1040
M8	25	11	100	1085
M8	25	13	100	1278
M8	30	11	100	1242
M8	30	13	100	1481
M8	40	13	100	1971
M8	50	13	50	2988
M8	60	13	50	3636
M10	20	17	50	1458
M10	25	17	50	1823
M10	30	13	100	1643
M10	30	17	50	2183
M10	40	13	50	2192
M10	40	17	50	2911
M10	50	17	50	3636
M10	60	17	25	4496
M10	70	17	25	5283
M12	25	19	50	2300
M12	30	17	50	2687
M12	30	19	50	2831
M12	40	17	50	3407
M12	40	19	50	3735
M12	50	17	25	4239
M12	50	19	25	4689
M12	60	19	25	5616
M12	70	19	25	6489
M14	40	22	50	4496
M14	50	22	25	5517
M16	30	24	25	4059
M16	40	22	50	4941
M16	40	24	25	5391
M16	50	22	25	6206
M16	50	24	25	6768
M16	60	24	25	8901

BEST.EX: DISTANSMUTTER 6-KANT M5 x 10 x 8 FZB
DATA.EX: HDN05010081

DISTANSMUTTER

6-KANT
STÅL FZB

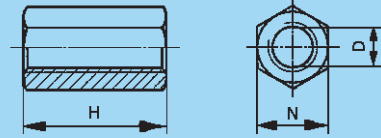

D	H	N	FÖRPACKNINGAR	PRIS KRONOR PER 100 ST.
M18	50	27	25	9284
M20	40	30	25	8199
M20	50	27	25	9284
M20	50	30	25	10202
M20	60	30	25	12006
M22	50	32	25	11457
M24	40	36	25	10778
M24	50	36	25	13158
M24	60	36	25	15795
M27	50	41	25	17325
M30	50	41	25	17325
M30	50	46	25	24440
M30	60	46	25	29327
M36	60	55	25	44910

BEST.EX: DISTANSMUTTER 6-KANT M18 x 50 x 27 FZB
DATA.EX: HDN18050271

BUFAB

DISTANSMUTTER

RUND
STÅL FZB

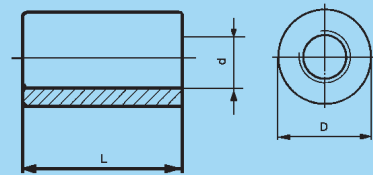

d	L	D	FÖRPACKNINGAR	PRIS KRONOR PER 100 ST.
M4	15	7	200	644
M4	20	7	200	720
M5	20	8	200	680
M5	25	8	200	738
M6	10	10	200	936
M6	15	10	200	545
M6	20	10	100	626
M6	25	10	100	675
M6	30	10	100	783
M6	35	10	100	1004
M6	40	10	100	1076
M6	50	10	100	1985
M8	15	11	100	626
M8	20	11	100	675
M8	25	11	100	725
M8	30	11	100	828
M8	35	11	100	1125
M8	40	11	100	1202
M8	50	11	100	2007
M10	20	13	100	876
M10	25	13	100	1040
M10	30	13	100	1125
M10	35	13	100	1341
M10	40	13	100	1566
M10	50	13	50	2435
M10	60	13	50	2997
M12	20	15	100	1031
M12	25	15	100	1139
M12	30	15	100	1629
M12	35	15	100	1931
M12	40	15	100	2255
M12	50	15	50	3335
M12	60	15	50	4266
M16	40	22	50	4487
M16	40	25	25	4991
M16	50	22	25	5657
M16	50	25	25	6269
M16	60	22	25	7443
M16	60	25	25	8343
M16	70	25	25	9653
M16	80	25	25	11007
M20	40	28	25	7821
M20	50	28	25	9734
M20	60	28	25	11682
M20	80	28	25	17055

BEST.EX: DISTANSMUTTER RUND M4 x 15 x 7 FZB

DATA.EX: RDN04015071

PRESSMUTTER

KALEI®/BULEI
SÄTTHÄRDAT STÅL FZB

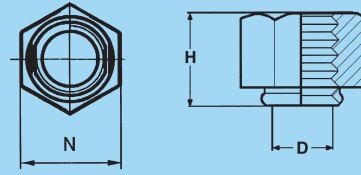

D	N	H	MIN PLÅT- TJOCKLEK	FÖRPACKNINGAR	PRIS KRONOR PER 100 ST.	
					KALEI	BULEI
M2,5	5,5	3,0	1	500	673	
M3	5,5	3,0	1	500	567	
M4	7,0	3,2	1	500	573	
M5	8,0	4,0	1	500	750	
M6	10,0	5,0	1	250	921	
M8	13,0	6,5	2	250	1204	1100
M10	15,0	8,0	2	250	2195	1900
M12	17,0	10,0	3	250	2856	
M16	22,0	13,0	3	250	7175	
M20	27,0	16,0	4	250	10750	

BEST.EX: PRESSMUTTER KALEI M2,5 FZB
DATA.EX: KALEI0251

NITMUTTER

**ANCHOR ARB
BN 196
STÅL FZB**

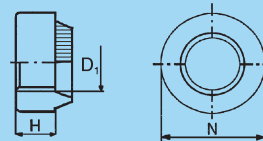

D	H	N	MATERIAL- TJOCKLEK	FÖR- PACKNINGAR	PRIS KRONOR PER 100 ST.
M3	3,2	7,9	0,5-1,6	100	519
M3	3,2	7,9	1,7-2,4	100	651
M3	3,2	7,9	2,5-3,7	100	822
M3	3,2	7,9	3,8-5	100	693
M4	3,8	9,5	0,5-1,6	100	561
M4	3,8	9,5	1,7-2,4	100	576
M4	3,8	9,5	2,5-3,7	100	591
M4	3,8	9,5	3,8-5	100	885
M5	4,4	11,1	0,5-1,6	100	606
M5	4,4	11,1	1,7-2,4	100	600
M5	4,4	11,1	2,5-3,7	100	1008
M5	4,4	11,1	3,8-5	100	1026
M6	5,7	12,7	0,5-1,6	100	690
M6	5,7	12,7	1,7-2,4	100	717
M6	5,7	12,7	2,5-3,7	100	726
M6	5,7	12,7	3,8-5	100	906
M8	6,4	15,9	0,5-2	100	1134
M8	6,4	15,9	2,1-3,7	100	1596
M8	6,4	15,9	3,8-5	100	1566
M10	7,6	19,1	0,5-2	100	1986
M10	7,6	19,1	2,1-3,7	100	1974
M10	7,6	19,1	3,8-5	100	2148
M12	10,2	25,4	0,5-3	100	4800

BEST.EX: NITMUTTER M3 FZB ANCHOR ARB MATERIALTJOCKLEK 0,5-1,6
DATA.EX: NM03051

UL6M

UNC-GÄNGA
ANSI B 18.2.2 (SMS 1991)
STÅL OBEH/FZB/FZV

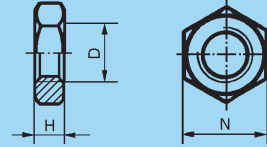

D	N (mm)	N (tum)	H	FÖRPACKNINGAR	PRIS KRONOR PER 100 ST.		
					OBEH	FZB	FZV
1/4	11,1	7/16	4,0	200		149	
5/16	12,7	1/2	4,8	200		165	
3/8	14,3	9/16	5,6	200		480	
1/2	19	3/4	7,9	200		565	
5/8	23,8	15/16	9,5	200		1200	
3/4	28,6	1 1/8	10,7	100		1900	2200
7/8	33,3	1 5/16	12,3	25		3900	
1"	38,1	1 1/2	13,9	25	5900	6800	
1 1/2	57,1	2 1/2	21,4			16200	

BEST.EX: UL6M STÅL 1/4 UNC FZB

DATA.EX: 439U141

KOMBIMUTTER

M LÅSBRICKA
BN 1364

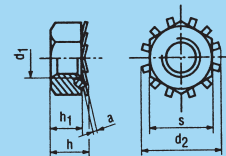

d ₁	d ₂	h	h ₁	a	s	FÖRPACKNINGAR	PRIS KRONOR PER 100 ST.
M3	6,8	3,4	2,4	0,45	5,5	100	124
M4	8,5	4,25	3,2	0,45	7	100	134
M5	9,5	5,25	4	0,5	8	100	138
M6	12	6,45	5	0,6	10	100	144
M8	15,5	8,25	6,5	0,8	13	100	225
M10	20,1	9,8	8	0,9	17	100	1160

BEST.EX: KOMBI-MUTTER M3 MED LÅSBRICKA

DATA.EX: BN1364031

MUTTERSÄKRING

DIN 7967
FJÄDERSTÅL OBEH/ FZB



D FÖR GÄNGA	N	H	FÖR- PACKNINGAR	ART. NR OBEH	ART.NR FZB	PRIS KRONOR PER 100 ST.	
						OBEH	FZB
M6	10	3	1000	7967053	79670531	174	197
M8	13	3,5	1000	7967069	79670691	225	255
M10	17	4	1000	7967086	79670861	270	320
M12	19	4,5	1000	7967104	79671041	359	417
M14	22	5	500	7967120	79671201	833	923
M16	24	5	500	7967141	79671411	539	630
M20	30	6	500	7967176	79671761	732	900
M22	32	6	200	7967196	79671961	1823	1980
M24	36	7	200	7967210	79672101	1328	1575
M27	41	7	100	7967242	79672421	2610	2970
M30	46	8	100	7967266	79672661	3015	3465
M33	50	8	50	7967298	79672981	4005	4635
M36	55	9	50	7967322	79673221	9788	10575
M42	65	11	50	7967376	79673791	14400	15525
M48	75	14	25	7967439	79674391	20925	22950

BEST.EX: DIN 7967 STÅL M6 OBEH
DATA.EX: 7967053

PRESSMUTTER

BN 201
SÄTTHÄRDAT STÅL FZB

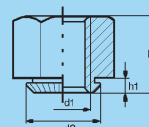

D	N	h1	MIN PLÅT- TJOCKLEK	H	FÖR- PACKNINGAR	ART. NR	PRIS KRONOR PER 100 ST.
M2	5,5	0,9	1	3	100	PM020091	729
M2,5	5,5	0,9	1	3	100	PM025091	561
M3	5,5	0,9	1	3	100	PM030091	372
M3	5,5	1,8	2	3	100	PM030181	663
M4	7	0,9	1	3,2	100	PM040091	390
M4	7	1,8	2	4,5	100	PM040181	471
M5	8	0,9	1	4	100	PM050091	558
M5	8	1,8	2	5	100	PM050181	639
M6	10	0,9	1	5	100	PM060091	738
M6	10	1,8	2	5	100	PM060181	708
M8	13	1,8	2	6,5	100	PM080181	852
M10	15	1,8	2	8	100	PM100181	1416
M12	17	2,8	3	10	100	PM120281	2076
M16	22	2,4	3	13	100	PM160241	5610
M20	27	3,9	4	16	100	PM200391	8160

BEST.EX: PRESSMUTTER M2 h1=0,9 FZB
DATA.EX: PM020091

DIN 981

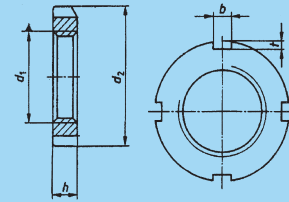

STÅL OBEHANDLAD

KM	d1 (M)	d2 h 13	h h 13	b js 14	t	FÖRP.	PRIS KRONOR PER 100 ST.
0	10 x 0,75	18	4	3	2	250	960
1	12 x 1	22	4	3	2	250	1190
2	12 x 1	25	5	4	2	250	1290
3	17 x 1	28	5	4	2	250	1430
4	20 x 1	32	6	4	2	250	1650
5	25 x 1,5	38	7	5	2	100	2290
6	30 x 1,5	45	7	5	2	100	2790
7	35 x 1,5	52	8	5	2	100	3860
8	40 x 1,5	58	9	6	2,5	100	4700
9	45 x 1,5	65	10	6	2,5	100	6070
10	50 x 1,5	70	11	6	2,5	50	7230
11	55 x 2	75	11	7	3	50	8730
12	60 x 2	80	11	7	3	50	9580
13	65 x 2	85	12	7	3	50	12880
14	70 x 2	92	12	8	4	24	14330
15	75 x 2	98	13	8	4	25	16300
16	80 x 2	105	15	8	4	25	19140
17	85 x 2	110	16	8	4	15	21510
18	90 x 2	120	16	10	4	15	23820
19	95 x 2	125	17	10	4	15	26470
20	100 x 2	130	18	10	4	10	30320
21	105 x 2	140	18	12	5	10	37710
22	110 x 2	145	19	12	5	5	39330
23	115 x 2	150	19	12	5	5	44210
24	120 x 2	155	20	12	5	5	44210
25	125 x 2	160	21	12	5	5	51260
26	130 x 2	165	21	12	5	5	51260
27	135 x 2	175	22	14	5	5	56390
28	140 x 2	180	22	14	5	5	69260
29	145 x 2	190	24	14	6	5	73080
30	150 x 2	195	24	14	6	4	77780
31	155 x 3	200	25	16	7	3	81530
32	160 x 3	210	25	16	7	3	101000
33	165 x 3	210	26	16	7	3	103150
34	170 x 3	220	26	16	7	3	120190
36	180 x 3	230	27	18	8	3	127500
38	190 x 3	240	28	18	8	3	128150
40	200 x 3	250	29	18	8	3	131600

BEST.EX: DIN 981 STÅL KM0 M10 x 0,75 OBEH

DATA.EX: 981010075

LÅSMUTTER CRN

MED PLÅSTINSATS
STÅL FÖRZINKAD

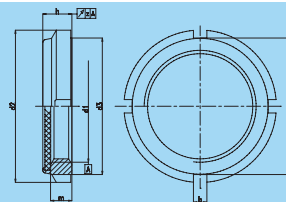

CRN	d ₁ (M)	d ₂ h 11	d ₃ =t -0,5	h max	b H 13	ANTAL	FÖRP.	PRIS KRONOR PER 100 ST.
0	10 x 0,75	18	15	7,6	3	4	250	1420
1	12 x 1	21	18	7,6	3	4	250	1560
2	15 x 1	24	21	8,6	4	4	250	1620
3	17 x 1	28	24	8,7	4	4	250	1970
4	20 x 1	32	27	9,6	4	4	250	2290
5	25 x 1,5	38	33	10,5	5	4	100	3140
6	30 x 1,5	44	38	10,7	5	4	100	3820
7	35 x 1,5	50	44	11,3	5	4	100	4740
8	40 x 1,5	56	50	12,3	6	4	100	5940
9	45 x 1,5	62	55	12,3	6	4	100	7250
10	50 x 1,5	68	61	12,9	6	4	50	8520
11	55 x 2	75	68	13,4	7	6	50	11860
12	60 x 2	80	73	13,4	7	6	50	12920
13	65 x 2	85	77	14,5	7	6	50	16050
14	70 x 2	92	84	14,5	8	6	25	20280
15	75 x 2	98	89	15,5	8	6	25	20930
16	80 x 2	105	96	16,5	10	8	25	27650
17	85 x 2	110	100	17,5	10	8	15	30600
18	90 x 2	120	110	17,7	10	8	15	33880
19	95 x 2	125	115	18,7	10	8	15	37630
20	100 x 2	130	120	19,7	10	8	10	40550

BEST.EX: LÅSMUTTER CRN 0 M10 x 0,75 FÖRZINKAD
DATA.EX: 9810100751CRN

LÅSMUTTER CRP

MED PLÅSTINSATS
STÅL FÖRZINKAD

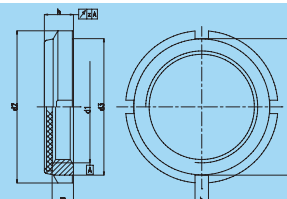

CRP	d ₁ (M)	d ₂ h 11	d ₃ =t -0,5	h max	b H 13	ANTAL	FÖRP.	PRIS KRONOR PER 100 ST.
4	20 X 1	32	27	13,2	4	4	250	2360
5	25 X 1,5	38	33	14,2	5	4	100	3580
6	30 X 1,5	44	38	14,2	5	4	100	4320
7	35 X 1,5	50	44	15,2	5	4	100	5450
8	40 X 1,5	56	50	16,7	6	4	100	6830
9	45 X 1,5	62	55	16,7	6	4	100	8300
10	50 X 1,5	68	61	18,7	6	4	50	10400
11	55 X 2	75	68	18,7	7	6	50	14500
12	60 X 2	80	73	18,7	7	6	50	16150
13	65 X 2	85	77	19,7	7	6	50	17980
14	70 X 2	92	84	19,7	8	6	25	22900
15	75 X 2	98	89	20,7	8	6	25	23680
16	80 X 2	105	96	20,7	10	8	25	29600
17	85 X 2	110	100	21,7	10	8	15	32550
18	90 X 2	120	110	21,7	10	8	15	36450
19	95 X 2	125	115	22,2	10	8	15	40550
20	100 X 2	130	120	24,2	10	8	10	44080

BEST.EX: LÅSMUTTER CRP 4 M20 x 1 FÖRZINKAD
DATA.EX: 9810201001CRP